

# Toward a Science of Sustainability

**Report from  
Toward a Science of Sustainability Conference  
Airlie Center ~ Warrenton, Virginia  
November 29, 2009 – December 2, 2009**

Simon A. Levin, William C. Clark, Eds.

CID Working Paper No. 196  
May 2010

© Copyright 2010 S. A. Levin, W. C. Clark, et al. and the  
President and Fellows of Harvard College.





Toward a Science of Sustainability:  
Report from Toward a Science of Sustainability Conference  
Airlie Center ~ Warrenton, Virginia  
November 29, 2009 – December 2, 2009

Simon A. Levin and William C. Clark, Eds.

**Abstract**

This report presents an overview of research horizons in sustainability science. Its motivation is to help harness science and technology to foster a transition toward sustainability – toward patterns of development that promote human well-being while conserving the life-support systems of the planet. It builds on but does not explicitly address the vast range of relevant sector-specific and cross-sectoral problem-solving work now underway in fields ranging from green technologies in energy and manufacturing to urban design to agriculture and natural resources. It focuses on the narrower but essential task of characterizing the needs for fundamental work on the core concepts, methods, models, and measurements that, if successful, would support work across all of those sectoral applications by advancing fundamental understanding of the science of sustainability.

The report emerged from a workshop sponsored by the National Science Foundation at Airlie Center in late 2009 under the direction of Simon A. Levin (Princeton University) and William C. Clark (Harvard University). It brought together thirty-eight scientists and practitioners from across a broad spectrum of disciplines. Building on a series of commissioned background papers included in the report, working groups addressed a wide range of conceptual, methodological, and empirical issues now facing sustainability science. The workshop thus constitutes the first US-based effort in a decade to create a systematic, community-based evaluation of the state of the field and to identify research priorities reaching across the full substantive and methodological breadth of the sciences of sustainability.

The report sets forth the workshop's findings and recommendations on six fundamental questions now facing scholars seeking to harness science and technology to foster sustainability:

- 1. What are the principal tradeoffs between human well-being and the natural environment, and how are those tradeoffs mediated by the ways in which people use nature?*
- 2. What determines the adaptability of coupled human-environment systems and, more broadly, their vulnerability and robustness/resilience in the face of external shocks and internal dynamics?*
- 3. What shapes the long term trends and transitions that set the stage on which human-environment interactions are played out?*
- 4. How can theory and models be formulated that better account for the variation in types or trends of human-environment interactions?*
- 5. How can society most effectively guide or manage human-environment systems toward a sustainability transition?*
- 6. How can the "sustainability" of alternative trajectories of human-environment interactions be usefully and rigorously evaluated?*

**Keywords:** sustainability science, sustainability transition, sustainable development, sustainability, human-environment systems, environmental policy, environment and development, science and technology

**JEL subject codes:** Q01, Q56, O31, O32, O33, F02, I3

## Citation and Acknowledgements

This paper may be cited as:

Levin, Simon A., and William C. Clark, Eds. "Toward a Science of Sustainability: Report from Toward a Science of Sustainability Conference, Airlie Center, Warrenton, Virginia, November 29, 2009 – December 2, 2009." CID Working Paper No. 196. Center for International Development at Harvard University. May 2010.

It is available at <http://www.hks.harvard.edu/centers/cid/publications/faculty-working-papers/cid-working-paper-no.-195>. Comments are welcome and may be directed to the lead author, William C. Clark, [william\\_clark@harvard.edu](mailto:william_clark@harvard.edu).

Support of the National Science Foundation through the Office of Multidisciplinary Activities, Division for Mathematical Sciences, Directorate for Mathematical and Physical Sciences; Directorate for Biological Sciences; Directorate for Computer and Information Science and Engineering; Directorate for Engineering; Directorate for Geosciences; and Directorate for Social, Behavioral and Economic Science is gratefully acknowledged.

Support of the Sustainability Science Program at Harvard's Center for International Development and the Italian Ministry for the Environment, Land and Sea is also gratefully acknowledged.

The views expressed in this paper are those of the author and do not necessarily reflect those of the Center for International Development, of the John F. Kennedy School of Government, or of Harvard University. The Working Papers are produced to elicit feedback and to encourage debate on important public policy challenges.

# ***Toward a Science of Sustainability***

**Report from Toward a Science of Sustainability Conference  
Airlie Center ~ Warrenton, Virginia  
November 29, 2009 – December 2, 2009**

***Funded by:***

## **The National Science Foundation**

Directorate for Mathematical and Physical Sciences  
Division for Mathematical Sciences  
Office of Multidisciplinary Activities

Directorate for Biological Sciences

Directorate for Computer and Information Science and Engineering

Directorate for Engineering

Directorate for Geosciences

Directorate for Social, Behavioral and Economic Sciences

***Organizers:***

**Simon A. Levin**  
Princeton University

**William C. Clark**  
Harvard University

***Date of Report:***

**March 30, 2010**

## Contents

### Pages 4-10

#### **Toward a Science of Sustainability: Executive Summary**

*William C. Clark, Simon A. Levin*

### Pages 11-22

#### **Working Group I: Human Well-Being and the Natural Environment**

*Kai M.A. Chan, Lisa M. Curran, Partha Dasgupta, J. Doyne Farmer, Avner Friedman, Jill Jäger, Granger Morgan, Stephen Polasky, Billie L. Turner II, Monica G. Turner*

### Pages 23-37

#### **Working Group II: Human-Environment Systems (HES) as Complex Adaptive Systems**

*J. Marty Anderies, Arun Agrawal, John Crittenden, Ann P. Kinzig, Simon A. Levin, Jianguo Liu, Samuel George Philander, Katharine R.E. Sims, Mary Lou Zeeman*

### Pages 38-55

#### **Working Group III: Measuring and Monitoring Progress Toward Sustainability**

*Krister P. Andersson, Stephen R. Carpenter, Jeannine Cavender-Bares, Jonathan Foley, John Guckenheimer, Shaleen Jain, Robert W. Kates, Veerabhadran Ramanathan, Jessika Trancik*

### Pages 56-71

#### **Working Group IV: Managing Human-Environment Systems for Sustainability**

*F. Stuart Chapin III, Carole L. Crumley, Carla P. Gomes, Thomas E. Graedel, Jacob Levin, Pamela A. Matson, Kira Matus, Samuel Myers, V. Kerry Smith*

### Appendix A: Pages 72-76

#### **List of Conference Participants with Affiliations**

### Appendix B: Pages 77-78

#### **Agenda for the Conference**

### Appendix C: Pages 79-156

#### **Background Papers for the Conference**

*List of Papers (Page 79)*

*Overview (Pages 80-100)*

#### 1. Sustainable Development and Sustainability Science

*William C. Clark (Pages 80-100)*

*Human Well-Being and the Natural Environment (Pages 101-117)*

2. Human Well Being and the Natural Environment:  
A Focus on Ecosystem Services (Pages 101-108)  
*Ann P. Kinzig*

3. Sustainable Development and Comprehensive Wealth (Pages 109-117)  
*Partha Dasgupta*

*Human-Environmental Systems as Complex Adaptive Systems (Pages 118-128)*

4. A Landscape Perspective on Sustainability Science (Pages 118-122)  
*Monica G. Turner*

5. Complex Adaptive Systems and the Challenge of Sustainability (Pages 123-128)  
*Simon A. Levin*

*Measuring and Monitoring Progress Toward Sustainability (Pages 129-141)*

6. Measuring and Monitoring Progress Toward Sustainability (Pages 129-133)  
*Stephen R. Carpenter*

7. Measuring and Monitoring Toward Sustainability (Pages 134-141)  
*Veerabhadran Ramanathan*

*Managing Human-Environmental Systems for Sustainability (Pages 142-156)*

8. Managing Human-Environmental Systems for Sustainability (Pages 142-146)  
*Arun Agrawal*

9. Managing Human-Environmental Systems for Sustainability:  
The Ultimate Systems Problem (Pages 147-156)  
*Thomas E. Graedel*

**Appendix D: 157-164**

**Summary of Themes and Research Questions Identified by the Working Groups**

## Toward a Science of Sustainability: Executive Summary of the 2009 Airlie Center Workshop

*William C. Clark, Simon A. Levin*

Fostering a transition toward sustainability – toward patterns of development that promote human well-being while conserving the life support systems of the planet – is one of the central challenges of the twenty first century (NRC, 1999a). Science and technology are generally recognized to be essential ingredients of society's efforts to foster such a transition (Interacademy Panel 2000, ICSU 2002). Building a science of sustainability nonetheless requires a truly multi-disciplinary approach that integrates practical experience with knowledge and know-how drawn from across the natural and social sciences, medicine and engineering, and mathematics and computation. The beginnings of such an approach have been taking shape over the last decade within a variety of forums, and are now coming together under the rubric of “sustainability science” (NRC 1999a, Kates et al. 2001, ICSU 2002, NSF 2003, Schellnhuber et al. 2004, Clark 2007, Matson 2009). Summaries of progress to date and priorities for action have recently been prepared reflecting European (Jäger 2009, European Commission 2009) and Asian (Komiya et al. 2010) perspectives on this endeavor. Not for a decade, however, has there been conducted in the United States a systematic, community-based attempt to evaluate progress and to identify research priorities reaching across the full substantive and methodological breadth of the sciences of sustainability. A comprehensive assessment of research needs and opportunities for advancing sustainability would need to include a vast range of sector-specific and cross-sectoral problem-solving work in fields ranging from green technologies in energy and manufacturing to urban design to agriculture and natural resources. We report here on the results of a three-day workshop organized to contribute to a narrower but essential task: characterizing the needs for fundamental work on the core concepts, methods, models, and measurements that, if successful, would support work across all of those sectoral applications by advancing fundamental understanding of the science of sustainability.

The workshop was conducted at Airlie Center in late 2009 with the encouragement and support of the National Science Foundation under the direction of Simon A. Levin (Princeton University) and William C. Clark (Harvard University). It brought together forty scientists and practitioners from across a broad spectrum of disciplines (see Appendix A). Participants were organized into four multidisciplinary working groups, focused respectively on: 1. The relationships between human well-being and the natural environment; 2. Human-environment systems as complex adaptive systems; 3. Managing human-environment systems for sustainability; and 4. Measuring and monitoring progress toward sustainability. The groups met independently and periodically reported out in plenary session. (The workshop agenda is provided in Appendix B). To maintain cross-talk, at some times only three groups met simultaneously, with members of the fourth group spread among them. One general overview paper and two short discussion papers for each group were circulated in advance of the workshop (see Appendix C).



Participants were invited to comment on these background papers before the workshop, with results posted to a dedicated website. Each working group was led by a moderator and a rapporteur. Rapporteurs produced draft reports during the workshop, which were then discussed both in working group meetings and in plenary. Revised versions of the working group reports, incorporating post-workshop comments from participants, constitute the body of this document. Each working group report provides a summary of the charge to the participants, a general discussion of the main research challenges identified by the group, and a set of specific research questions recommended as meriting priority attention by the group. Those detailed questions are summarized in point form in Appendix D of this report. Rather than reproduce them in this Executive Summary, we instead highlight below several of the major thematic needs for research and infrastructure development that emerged in plenary discussions of the working group reports.

*1. What are the principal tradeoffs between human well-being and the natural environment, and how are those tradeoffs mediated by the ways in which people use nature?* The workshop adopted a broad view of both human systems (potentially including their economic, social, health, and spiritual dimensions) and environmental systems (including ecosystem and life-support services, and the natural resources, biodiversity and, more generally, natural capital from which those services flow). It acknowledged that much was known about particular tradeoffs between human well-being and the natural environment, for example how efforts to meet human needs for energy through the use of fossil fuel resources result in changes to the climate, or how agricultural efforts to increase the yields of land and water resources generate nitrogen pollution. The time is ripe, however, for developing a more general characterization of how alternative patterns and processes in the human use of nature result in different tradeoffs, with the goal of understanding how maximal human well-being can be secured from available natural capital. In particular, there is a need to organize both historical evidence and existing theories of human-environment systems into typologies or classifications that capture alternative modalities possible in the human use of the earth.

*2. What determines the adaptability of coupled human-environment systems and, more broadly, their vulnerability and robustness/resilience in the face of external shocks and internal dynamics?* Human-environment systems are complex and adaptive, but there are limits to their adaptability. One result is the apparent ubiquity of threshold or “tipping point” behaviors in such systems. Despite much study of such phenomena, however, we presently have only the beginnings of an understanding of the vulnerability and resilience of coupled human-environment systems. Research is needed to understand how shocks – both undesirable and intended – cascade across spatial scales and organizational levels to impact such systems, and whether there are structural properties that can amplify or damp such cascades. We need to better understand how and to what extent the existence of relevant thresholds can be systematically predicted, and whether there are ways of reliably sensing that the system is approaching such thresholds. Finally, we need to understand at a more generalizable level which features of coupled human-environment systems enhance and which constrain their adaptability. In particular, how do the features that confer robustness and resilience translate across

scales?

3. *What shapes the long term trends and transitions that set the stage on which human-environment interactions are played out?* Sustainability science has focused on understanding “the large and the long” in human-environment interactions – patterns that play out over periods of decades to centuries and over significant expanses of space. Workshop participants identified a need for a comprehensive look at large-scale, long term driving forces of special relevance to sustainability. This would include: a. Identifying a system-wide scale changing patterns in the human use of critical resources and natural capital more broadly; b. A critical reexamination of such popular notions as the demographic and health transitions, the urbanization transition, dematerialization and the decoupling of economic growth and energy use; c. Exploring less well-developed areas such as abrupt and lasting shifts in attitudes, long term changes in consumption behavior, and the linkage of such trends to human satisfaction and perceived well-being. Beyond documenting such trends, research is needed on their determinants and the prospects for altering them through policy and other interventions. In particular, we need a better understanding – informed by both history and theory – of the determinants of geographical, temporal and sectoral variation in long term trends and transitions that are of special relevance to sustainability

4. *How can theory and models be formulated that better account for the variation in types or trends of human-environment interactions?* Many properties of human-environmental systems can be adequately captured with conventional statistical or system-dynamic models. But the complex dynamics, inter-sectoral and multi-scale interactions, emergent properties and uncertainty that characterize many of the human-environment systems most relevant to sustainability concerns have proven very difficult to deal with using such approaches. Advances in agent-based and network approaches to the modeling of complex adaptive systems offer promise of doing better, as do several approaches to the qualitative analysis of non-linear systems and the development of interdisciplinary, multi-scale scenarios. But that promise has not yet been fulfilled in more than a handful of cases. Part of the problem is that most empirical scientists who understand the causal structure of human-environment systems are not expert in the new modeling approaches, while modeling experts seldom have access to more than “toy” systems and simple data sets. The workshop concluded that much could be gained from a concerted effort to compare the ability of a suite of promising modeling approaches to shed light on a few well-understood human-environment systems. Reciprocally, sustainability science would certainly benefit greatly from developing its own suite of “model systems” to play the roles that stalwarts such as *Drosophila*, *E. coli*, and lynx-hare interactions have played for other sciences. Such model systems – including long term, spatially explicit data sets of key variables, a summary of key causal relationships, and a catalogue of models already developed for them – would attract the attention of new families of complex system theorists and modelers to the field. A good start might be made with fish-stock/fishery fleet systems of the sort recently reviewed by C.W. Clark (2006) and the lake/agricultural pollution systems developed by Carpenter (Brock and Carpenter 2007).

5. *How can society most effectively guide or manage human-environment systems toward a sustainability transition?* Efforts to manage human-environment systems for sustainability must squarely address challenges of complexity, uncertainty, and the diversity of goals held by different stakeholders. Recent work in the governance of such systems strongly suggests that homogeneous, static “blueprint” approaches are not up to the task. But if “polycentric” approaches are almost surely needed, questions remain about how to design and manage them. Research is particularly needed on: a. How individual human behaviors translate into collective decision-making; b. How to tailor incentives for research and innovation so that the results meet the needs of specific practitioners in particular places rather than merely reflecting the generalized priorities of scholars; c. How to integrate general knowledge from scholarship with specific knowledge of practice; d. How to facilitate adaptive governance through institutional flexibility and the use of appropriate monitoring data as feedback; e. How to develop assessment procedures that will promote useful evaluation of alternative interventions despite conditions of high technical uncertainty and low political consensus.

6. *How can the “sustainability” of alternative trajectories of human-environment interactions be usefully and rigorously evaluated?* The workshop identified the need for rigorous conceptual frameworks to facilitate comparison of how well different patterns in human use of the natural environment perform relative to sustainability goals. The central goal of such frameworks is to help us understand which uses of the natural environment (seen as natural capital) generate sufficiently large, wide-spread and long term benefits to human well-being that they can be valued as supporting sustainable development. (Having an answer to this challenge is what keeps ‘sustainability’ from being a euphemism for ‘environmental protection.’) Key challenges for the design of such frameworks include how to deal with population growth, time tradeoffs (discounting and intergenerational equity), space tradeoffs (intra-generational equity), and the role of institutions and knowledge. To make such valuation frameworks operational, however, they must be tightly integrated with systems for monitoring and reporting on the key variables (human, resource, and environmental) that they incorporate. Since many of the variables that are most attractive on theoretical grounds will remain unmeasurable in practice at relevant scales, the need is to design valuation and monitoring systems in tandem. This is an enormously difficult task that has not yet been successfully performed in the domain of sustainable development. Improving the record will require: a. Fundamental research into what kinds of evaluation and monitoring systems are most needed; b. Systems analysis of what is already being adequately measured and what is not at relevant scales; c. Operational support for collaborative processes to design and put in place the missing pieces, and d. Synthesis efforts to report out the results in forms useful for decision support at relevant scales of management and governance. Carrying out these complex and demanding tasks successfully will require full and creative utilization of emerging cyberinfrastructure capabilities.

\* \* \*

In addition to the central research and development tasks outlined above, the successful promotion of the nascent field of sustainability science will require substantial investment in infrastructure. This workshop was not designed to dig deeply into infrastructure needs.

Nonetheless, several priority needs emerged relatively clearly from our discussions:

*7. Focused follow-up efforts to develop and fund detailed research programs to address the challenges identified in this and similar workshops are needed.* The temptation of interested disciplines to develop such efforts in isolation should be resisted. The experience of this workshop suggests that priority should be given to efforts that, though more focused than our broad survey, nonetheless engage scholars and practitioners from a relevant range of fields on equal footing.

*8. Short courses on the current theories, data, methods and unresolved questions of sustainability science.* These could well take the form of intensive summer institutes of the sort carried out by the global environmental change program in the 1980s and 1990s, or by the Santa Fe Institute efforts on complex systems over the last 20 years.

*9. Career development efforts are also needed to allow young scholars and practitioners to branch out beyond their core areas of expertise.* A variety of such efforts are now underway, ranging from formal degree programs in sustainability science to cross-training fellowships and the sorts of short-courses noted above. It is too early to know which of these efforts will contribute what to the emergence of the field. In these early years, it therefore makes sense to provide some support to all as we wait to see what they accomplish, and how the field develops.

*10. One or more forums for regular exchange between the academic, government, and non-governmental communities on current needs and accomplishments in the field.* This is the function often performed in the USA by Boards of the National Research Council. Building support for such a Board or its equivalent ought to receive serious attention. Internationally, the choice is less clear, though the workshop's brief review of the differences between North American, European and Asian approaches to sustainability science shows unequivocally that some such a forum is needed. The AAAS is supporting one small effort to meet this need in its virtual Forum on Science and Innovation for Sustainability ([sustainabilityscience.org](http://sustainabilityscience.org)). The efforts of the Earth System Science Partnership to build long term collaborations with practice-oriented organizations such as the Consultative Group on International Agricultural Research suggests the kinds of operational initiatives that deserve consideration.

## References

- Brock, W.A. and S.R. Carpenter. 2007. Panaceas and diversification of environmental policy. *Proceedings of the National Academy of Sciences* 104(39): 15206-15211.
- Clark, C.W. 2006. *The Worldwide Crisis in Fisheries: Economic Models and Human Behavior*. Cambridge: Cambridge University Press.
- Clark, W.C. 2007. Sustainability science: A room of its own. *Proceedings of the National Academy of Sciences* 104: 1737.
- European Commission, Research Directorate General for Environment. 2009. *Report from the Workshop on Sustainability Science, Brussels, 28 October 2009*. RTD/I.2/ND/VG/cm D(2009)576942. Brussels: EC. Available from: [http://ec.europa.eu/.../report\\_workshop\\_sustainability\\_science\\_october\\_2009.pdf](http://ec.europa.eu/.../report_workshop_sustainability_science_october_2009.pdf).
- Interacademy Panel on International Issues. 2000. *Transition to Sustainability in the 21<sup>st</sup> Century*. Trieste: Interacademy Panel. Available from <http://www.interacademies.net/?id=3568>
- International Council for Science. 2002. *Science and Technology for Sustainable Development: Report from the Synthesis Meeting Sponsored by the Initiative on Science and Technology for Sustainability*. TWAS and ICSU Series on Science for Sustainable Development 9. Paris: ICSU.
- Jäger, J. 2009. *Sustainability Science in Europe*. (Background paper prepared for European Commission's DG for Research). Available from: [http://ec.europa.eu/research/sd/pdf/workshop2009/background\\_paper\\_sust\\_sciencE\\_workshop\\_october\\_2009.pdf](http://ec.europa.eu/research/sd/pdf/workshop2009/background_paper_sust_sciencE_workshop_october_2009.pdf).
- Kates, R.W. et al. 2001. Sustainability science. *Science* 292: 641-642.
- Matson, P.A. 2009. The sustainability transition. *Issues in Science and Technology*. In press.
- National Research Council (NRC), Policy Division, Board on Sustainable Development. 1999a. *Our Common Journey: A Transition Toward Sustainability*. Washington, DC: National Academies Press. Available from: [http://www.nap.edu/catalog.php?record\\_id=9690](http://www.nap.edu/catalog.php?record_id=9690).
- Komiyama, H., K. Takeuchi, H. Shiroyama, and T. Mino, eds. 2010. *Sustainability Science: A Multidisciplinary Approach*. Washington, DC: Brookings Institution Press.

National Research Council (NRC), Panel on Integrated Environmental and Economic Accounting. 1999b. *Nature's Numbers: Expanding the National Economic Accounts to Include the Environment*, ed. W.D. Nordhaus and E.C. Kokkelenberg. Washington, DC: National Academies Press. Available from: [http://www.nap.edu/catalog.php?record\\_id=6374](http://www.nap.edu/catalog.php?record_id=6374).

National Science Foundation (U.S.). 2003. *Complex Environmental Systems – Synthesis for Earth, Life and Society in the 21st Century: A 10-year Outlook for the National Science Foundation*. Washington, DC: NSF.

Schellnhuber, H.J., P.J. Crutzen, W.C. Clark, M. Claussen, and H. Held. 2004. *Earth System Analysis for Sustainability*. Cambridge: MIT Press.

## Working Group I: Human Well-Being and the Natural Environment

*Kai M.A. Chan, Lisa M. Curran, Partha Dasgupta, J. Doyne Farmer, Avner Friedman, Jill Jäger, Granger Morgan, Stephen Polasky, Billie L. Turner II, Monica G. Turner*

### Charge to the Working Group

The Human Well-Being and the Natural Environment Working Group was charged with identifying a small set of research challenges where progress could advance our understanding of the interdependence of human well-being and the natural environment. Understanding this interdependence is an essential foundation for sustainability science. The working group was specifically charged with directing attention towards developing an internally consistent framework for showing how use, and even depletion, of aspects of the natural environment could be consistent with sustainability so long as they are converted into other forms of capital (e.g. manufactured, human, social) at appropriate rates capable of maintaining human well-being over the long-term. Key issues for sustainable development involve the definition of human well-being, how natural capital contributes to human well-being, how human actions impact on natural capital, tradeoffs in benefits over space (intra-generational equity) and time (intergenerational equity), and the role of institutions, technology and knowledge in promoting sustainable development.

### Introduction

Human well-being is dependent upon “natural capital” that underlies the life-support system and the provision of goods and services of value to people. However, it is also true that human actions profoundly influence environmental conditions from the local to the global scale. Some commentators have dubbed the modern era as the “anthropocene” to denote the major impact that humans have in shaping the environment (Crutzen and Stoermer 2000). Given the impact the humans have on the environment and the fundamental role that the environment plays in supporting human well-being, sustainable development will require improved understanding of human-environment interactions and intelligent decisions to guide human actions in ways consistent with maintaining human well-being in the long-run.

Four research challenges that expand on elements of human-environment interactions that lie at the heart of sustainability science are described below. Each research challenge contains four to six specific research questions that focus on important aspects of the overall challenge. Each research challenge encompasses a large array of the fields of knowledge addressing sustainable development and the research questions within these challenges are sufficiently specified to be achievable. In the section for each of the four challenges, there is a brief explanation of the overall rationale for the challenge, how the challenge encompasses multiple fields of knowledge, what some of the major impediments to research have been to date, and why near-term progress in this area is possible. Neither the list of research challenges nor the list of research questions within each research challenge are meant to be comprehensive or rank ordered.

## Research Themes

- A. How can analysis contributing to decision-making about the sustainable development of human-environmental systems be improved?
- B. How can technological innovation be induced and harnessed to support sustainability?
- C. What are the implications of heterogeneous and changing consumption patterns for sustainable development, and what strategies related to consumption could enhance sustainable development?
- D. What are the relationships between collective social phenomena and sustainable development, and how can we explain these relationships?

## Unpacking the Themes and Articulating a Research Agenda

### *A. How Can Analysis Contributing to Decision-Making about the Sustainable Development of Human-Environmental Systems Be Improved?*

The interactions among natural capital, ecosystem services, and human well-being are pivotal to sustainability science. These interactions are complex and involve multiple tradeoffs that affect both conditions of the environment and its capacity to provide services that contribute to human well-being. The characterization of ecosystem services has only just begun to incorporate the mechanisms by which the provision of services are influenced by changes in human-environment systems, which is the innovative fundamental science on which sustainable development should be grounded. The complexity of tradeoffs inhibits comparisons among alternative decisions in sustainable development assessments and points to the need for improved means to do so. To reach this objective, however, requires a series of improvements in understanding and in methods (“tool kits”) to analyze sustainable development. Improved understanding is needed about the role of different measures/metrics on ecosystem services, human well-being, and time preferences, the implicit or explicit values embedded in various approaches, how tool kits are constructed, and what is included or excluded from them. In some cases, assumptions in standard approaches are at odds with empirical observations. For example, behavioral evidence indicates that people weigh present versus future consequences in ways inconsistent with conventional discounting approaches. It is also clear that both conventional analytical strategies and behaviorally revealed preferences can lead to outcomes that are inconsistent with long-term sustainable development. In addition, various research fields reveal that spatial and temporal patterns and dynamics of human-environment systems profoundly affect the tradeoffs and the analysis of alternatives. Fine-scale assessments (e.g., neighborhood or community) can point to solutions that may prove inappropriate given the coarse-scale (landscape or region) consequences of the same options, and vice versa. Finally, approaches to these and related tool kit development requires analysis to translate expected outcomes (in biophysical and social terms) into value terms (one- or multi-dimensional scores or rankings of alternatives). Various approaches have been subject of



considerable research in disjoint literatures in economics, decision science and other fields that would benefit from synthesis.

Major advances across the environmental, social, and decision sciences, remote sensing and spatial modeling, provide the foundation for a systematic treatment of this challenge and its research questions. These advances involve the best practices to determine what to measure and the means to do so across a range of ecosystem services (e.g., Bockstael et al. 2000, NRC 2005) and facets of human well-being linked to services (e.g., EPA 2009, TEEB 2009); major headway in improved models that can address the spatio-temporal patterns and dynamics of tradeoffs and their implications for sustainable development (Chan et al. 2006, Nelson et al. 2008, 2009, Wu 2004); and new approaches in decision-making processes (e.g., Ananda and Herath 2009, Gregory and Slovic 1997, Howarth and Wilson 2006, Kemp et al. 2007, Niemeyer and Spash 2001, Rotmans et al. 2007, Spash 2007).

### *Research Questions*

1. How can sustainable development outcomes be compared/evaluated/ranked?
2. What are the advantages and disadvantages of different measures of human well-being (e.g., psychological, economic, health and nutrition measures) and how can we aggregate measures of human well-being across different individuals and groups?
3. How can the measurement and valuation of ecosystem services be improved to better understand the link between environmental conditions and human well-being? What are the relationships between changes in social-ecological systems and changes in ecosystem services?
4. How can multiple tradeoffs among ecosystem services and other components of human well-being be quantified or characterized, and how can this best inform real-world decision-making?
5. How is decision-making informed and affected by the spatial or temporal scales of assessment and system dynamics?
6. How should assessments take account of intra-generational and inter-generational equity considerations in the comparisons/evaluations/rankings of sustainable development outcomes? In dealing with long-run consequences, are additional approaches besides discounting needed to aggregate across time?
7. How do different approaches (from expert-driven to deliberative democratic approaches) for treating values in the decision-making processes affect the comparisons/rankings of sustainable development outcomes? What factors determine the acceptability of different processes (and their associated outcomes) to participants and others?

### ***B. How Can Technological Innovation Be Induced and Harnessed to Support Sustainable Development?***

Consumption of physical goods and the associated life-cycle implications are at the root of many issues in sustainability. While technology adopted and used without consideration of its implications for sustainability can give rise to serious challenges, technology properly conceived and promulgated can also play a critical role in improving human well-being. Examples of simple technologies that are relatively easy and cheap to deploy, such as insecticide-treated bed nets to prevent malaria, water treatment to provide clean drinking water, and oral rehydration therapy to overcome diarrheal diseases have led to major improvement in health without major environmental impacts (Holdren 2008). Advances in technology will be needed in agriculture if we are to feed 9 – 10 billion people without increasing the environmental burden associated with production (Tilman et al. 2002). Technological advances will also be needed in energy production if we are to meet human needs and reduce carbon emissions (IPCC 2007). Similarly, social and economic environments and systems are important in determining which technologies get developed or adopted, how they are diffused, and whether they give rise to long-term capital or social “lock in” that makes it difficult or impossible in the future to adopt more sustainable technology-based strategies. Incentives for innovation and diffusion are often driven by private returns and ignore impacts on natural capital. Reorienting research, development and diffusion towards sustainable development will require proper pricing of natural capital so that impacts on the environment are given proper consideration in innovation and adoption of technology.

Major improvements in understanding the questions listed in this section can be achieved by recognition of various impediments and means by which they can be overcome. The economic research on technological innovation notwithstanding, much prior research does not “get inside the black box” to look at how the technical details shape the process, frame analysis in terms of a life-cycle perspective, or concern itself with the long-term social and physical externalities of specific technologies. Recent work on integrated assessments of the economy and climate (Hope 2006, Nordhaus and Boyer 2000) or comparisons of the life-cycle impacts of biofuel and fossil-fuel technologies (Hill et al. 2006, 2009) provide elements of an approach to analyze the sustainability of alternative policy and technology options. Similarly too little attention is given to issues of long-term sustainability, and the social and economic dynamics central to the adoption and benign use of technology. These impediments are not phenomenological in kind (tool kits and methods) but have followed from the paucity of incentives for research communities to expand sufficient effort on these dimensions. However, there does exist an active body of research on incentives for research, development and diffusion of technology that take account of the environment and sustainability (Jaffe et al. 2003).

#### *Research Questions*

1. How can technological innovations be evaluated to determine their importance to sustainability? What aspects of innovations (e.g., energy minimization, resource utilization, etc.) might be most useful for sustainable development?

2. How best can innovation be encouraged to reduce environmental impacts from existing technology be promoted and how best can innovations leading to environmental degradation be discouraged?

3. How well will different policies and regulatory mechanisms induce sustainable technical or social innovation, either by dramatically reduced life-cycle use of energy and materials, or through the substitution of low-impact services for products? How well will different policies and regulatory mechanisms promote rapid adoption and use of these technologies?

4. What strategies, policies and institutions can best avoid economic or political lock-in when technologies and their associated institutions are anticipated to be useful in the short term but potentially detrimental to long-term sustainability?

5. How can integrated assessments (including technical, engineering, economic, market components) be improved to develop confidence that large-scale subsidies for deploying a technology will (or will not) quickly drive costs down to a level that makes it competitive in the market or make it socially desirable when environmental and social consequences are included?

6. How can technology forecasting be improved to yield a greater probability that the outcome of projected variables will lie within projected confidence intervals, and thus better support choices for sustainable development?

7. What are the likely unintended consequences – both social and environmental – of adoption and diffusion of new technologies and how well can these consequences be predicted before the wide-scale adoption and diffusion of new technology? What are promising approaches to policy design to reduce negative (increase positive) side-effects of new technology?

***C. What Are the Implications of Heterogeneous and Changing Consumption Patterns for Sustainable Development, and What Strategies Related to Consumption Could Enhance Sustainable Development?***

Two large interconnected problems facing humanity in the 21<sup>st</sup> century are: a. the roughly one-quarter of the global population that lives in extreme poverty (defined as income of less than \$1.25 per day) and the roughly one-half of the global population that lives in on less than \$2.00 per day (World Bank 2009), and b. the high levels of total energy and material use leading to global change that threatens the life-support system of the planet. Increasing the material well-being of people in developing countries is a global priority, yet bringing the entire global population to levels of consumption prevalent in developed countries, given current technology, is unsustainable. Changing patterns of consumption relative to their environmental footprint will be necessary to simultaneously alleviate poverty and reduce threats to a sustainable earth system. Although the demographic transition has led to a slowing of population growth with rising income, no such slowing in consumption levels has so far appeared at the aggregate level with rising income. A major issue in sustainable development is how to continue to proceed with the

“democratization of consumption” (i.e., increasing the proportions of the global population that have adequate levels of income and consumption) and do so in an environmentally sustainable way (Sachs and Santarius 2007)? What pathways toward sustainable development that meet both social and environmental objectives are possible?

Research in economics, marketing, psychology and other fields has investigated many aspects of what motivates consumption and how consumption changes with income, demographics, education and other social factors, and how to relate long-term consumption to ultimate resource limits (e.g., National Research Council, 2008). How to motivate changes in behavior that lessen the environmental footprint of consumption requires integrating research across the social and behavioral sciences (e.g., economics, political science, psychology, sociology). Research in behavioral economics that seeks to integrate insights from psychology and economics (Camerer et al. 2003, Rabin 1998) and from evolutionary psychology (Jackson 2002) offers potential new avenues for improved understanding of consumption behavior. Gaining better understanding of how consumers use and dispose of products, the environmental impacts of these actions, and ways to better design products to reduce impacts, requires integration of behavioral and social sciences with the natural sciences and engineering. A number of promising areas of research on questions related to consumption and environmental impact include measuring the impact of consumption on sustainability (e.g., Jackson 2008, Priesen et al. 2002), how financial incentives, social norms, education and information provision interact to affect consumption behavior that impacts on the environment, whether increases in income and consumption are tied to improved subjective measures of well-being and happiness (e.g. Diener and Suh 1999, Easterlin 1974, 2001, Stevenson and Wolfers 2008), the impact of social, cultural and political factors on measures of subjective well-being (e.g., Helliwell 2006, Helliwell and Huang 2008, Helliwell and Putnam 2004), links between measures of subjective well-being and more objective measures such as life expectancy, literacy, nutrition or other measures.

### *Research Questions*

1. What is the relationship between resource consumption and human well-being and to what extent can the two be de-coupled?
2. What strategies can change high consumption patterns to reduce material/energy use while sustaining or improving human well-being?
3. What strategies can change low consumption patterns to better meet human needs while minimizing environmental impacts?
4. As wealth increases, what incentives and enabling conditions can lead to dematerialization of consumption (e.g., material use transition akin to the demographic transition) consistent with sustainable development?
5. What motivates consumption, especially of material and energy that affect sustainable development, and upon what factors does it depend?

6. How will changing demographics and education alter consumption patterns and sustainable development?

7. How can the resource utilization embodied in global consumption be related to and constrained by limits to resource availability?

***D. What Are the Relationships between Collective Social Phenomena and Sustainable Development, and How Can We Explain these Relationships?***

Scientists now have the requisite theoretical and methodological tools in place to productively tackle questions about the relationships between social phenomena and sustainable development. Efforts are underway to examine the trends and trajectories of long- and short-term processes as they affected the sustainability of coupled human-environment systems in the past (Dearing et al. 2006a, b). Current advances in network analyses and agent-based modeling make such research on sustainability a highly promising endeavor and call out for transdisciplinary projects to investigate sustainable development in a wide variety of environments, such as urban zones (from global cities to newly emerging ones), agricultural areas, and tropical rainforests. Recent developments on scaling relationships and network models in complex systems have shown the existence of striking regularities in several social phenomena, such as fertility and energy usage, or patent rates and city size (Bettencourt et al. 2007). Such regularities indicate that certain changes go hand-in-hand, for example, in the developed world as people move to cities their environmental footprint changes in a predictable way that depends on population density and total size. Are there more such factors to be discovered? What causes such relationships? In recent years advances in network analysis have given us a better understanding of social phenomena such as the Internet or the formation of terrorist networks (Clauset & Gleditsch 2009, Watts 2002, Watts and Dodds 2009). Can we anticipate when social innovations favorable to sustainable development might occur (Jäger 2009) or how social institutions are likely to evolve? The time is ripe to apply these same tools to questions of sustainable development, and the role of social networks in producing or blocking sustainable development.

A community of scholars doing research on scaling relationships and network analysis has emerged. This research is constrained by insufficient funding and good data, and the paucity of programs that encourage the use of these tools in analysis of sustainable development. Such an effort would involve an interdisciplinary interaction between social scientists, biologists, and physicists (who are some of the primary practitioners using these tools).

*Research Questions*

1. How does the rapid migration to cities influence sustainable development? What changes in social and population structures will follow and how will these changes affect sustainable development?

2. Are there scaling rules for sustainable development similar to those that have been observed relating city size, energy consumption, and production of intellectual capital? What factors underlie such rules?
3. How can network models and other innovative approaches be applied to achieve a better understanding of social interactions and their influence on sustainable development?
4. What factors differentiate institutions and their development that encourage or discourage sustainable development? Under what circumstances do institutions resist change rather than adapt and evolve to be more consistent with sustainable development?
5. To what extent might social innovations (e.g., a move to product services that reduce the need for each household to buy equipment they seldom use) serve to supplement and enhance technological solutions that promote sustainable development?
6. How can long-term paleo and historical evidence better inform current sustainability themes, including how long- and short-term processes led to successes and failures in coupled systems in the past?

## References

- Ananda, J. and G. Herath. 2009. A critical review of multi-criteria decision making methods with special reference to forest management and planning. *Ecological Economics* 68(10): 2535-2548.
- Bettencourt, L.M.A., J. Lobo, D. Helbing, C. Kuhnert, and G.B. West. 2007. Growth, innovation, scaling, and the pace of life in cities. *Proceedings of the National Academy of Sciences* 104(17): 7301-7306.
- Bockstael, N., A.M. Freeman, III, R.J. Kopp, P.R. Portney, and V.K. Smith. 2000. On measuring economic values for nature. *Environment, Society, and Technology* 34: 1384-1389.
- Camerer, C.F., G. Loewenstein, and M. Rabin (eds.). 2003. *Advances in Behavioral Economics*. Princeton University Press.
- Chan, K.M.A., M.R. Shaw, D.R. Cameron, E.C. Underwood, and G.C. Daily. 2006. Conservation Planning for Ecosystem Services. *PLOS Biology* 4: 2138-2152.
- Clauset, A. and K.S. Gleditsch. 2009. The developmental dynamics of terrorist organizations. *Physics and Society*. Available from: <http://arxiv.org/abs/0906.3287>.
- Crutzen, P.J. and E.F. Stoermer. 2000. The 'Anthropocene'. *Global Change Newsletter* 41: 17-18.
- Dearing, J.A., R.W. Battarbee, R. Dikau, I. Larocque, and F. Oldfield. 2006a. Human-environment interactions: learning from the past. *Regional Environmental Change* 6: 1-16.
- Dearing, J.A., R.W. Battarbee, R. Dikau, I. Larocque, and F. Oldfield. 2006b. Human-environment interactions: towards synthesis and simulation. *Regional Environmental Change* 6: 115-123.
- Diener, E. and E.M. Suh. 1999. National differences in subjective well-being. In *Well-Being: The Foundations of Hedonic Psychology*, ed. D. Kahneman, E. Diener and N. Schwarz. New York: Russell-Sage.
- Easterlin, R.A. 1974. Does economic growth improve the human lot? Some empirical Evidence. In *Nations and Households in Economic Growth: Essays in Honor of Moses Abramovitz*, ed. P.A. David and M.W. Reder. New York: Academic Press.
- Easterlin, R.A. 2001. Income and happiness: towards a unified theory. *Economic Journal* 111: 465-84.
- Gregory, R. and P. Slovic. 1997. A constructive approach to environmental valuation. *Ecological Economics* 21(3): 175-181.

- Helliwell, J.F. 2006. Well-being, social capital and public policy: What's new? *Economic Journal* 116: C34-C45.
- Helliwell, J.F. and H.F. Huang. 2008. How's your government? International evidence linking good government and well-being. *British Journal of Political Science* 38: 595-619.
- Helliwell, J.F. and R.D. Putnam. 2004. The social context of well-being. *Philosophical Transactions of the Royal Society of London Series B-Biological Sciences* 359: 1435-1446.
- Hill, J., E. Nelson, D. Tilman, S. Polasky and D. Tiffany. 2006. Environmental, economic, and energetic costs and benefits of biodiesel and ethanol biofuels. *Proceedings of the National Academy of Sciences* 103: 11206-11210.
- Hill, J., S. Polasky, E. Nelson, D. Tilman, H. Huo, L. Ludwig, J. Neumann, H. Zheng, and D. Bonta. 2009. Climate change and health costs of air emissions from biofuels and gasoline. *Proceedings of the National Academy of Sciences* 106(6): 2077-2082.
- Holdren, J. 2008. Science and technology for sustainable well-being. *Science* 319: 424-434.
- Hope, C.W. 2006. The marginal impact of CO<sub>2</sub> from PAGE2002: An integrated assessment model incorporating the IPCC's five reasons for concern. *Integrated Assessment Journal* 6(1): 19-56.
- Howarth, R.B. and M.A. Wilson. 2006. A theoretical approach to deliberative valuation: Aggregation by mutual consent. *Land Economics* 82(1): 1-16.
- Intergovernmental Panel on Climate Change (IPCC). 2007. *Climate Change 2007: Synthesis Report. Contribution of Working Groups I, II and III to the Fourth Assessment Report of the Intergovernmental Panel on Climate Change [Core Writing Team, ed. Pachauri, R.K and Reisinger, A.]*. Geneva: IPCC.
- Kemp, R., D. Loorbach, and J. Rotmans. 2007. Assessing the Dutch energy transition policy: how does it deal with dilemmas of managing transitions? *Journal of Environmental Policy and Planning* 9(3-4): 315-331.
- Jackson, T. 2002. Evolutionary psychology in ecological economics: consilience, consumption and contentment. *Ecological Economics* 41(2): 289-303.
- Jackson, T. 2008. Sustainable consumption and lifestyle change. In *Handbook of Economic Psychology*, ed. A. Lewis. Cambridge: Cambridge University Press.
- Jaffe, A.B., R.G. Newell, and R.N. Stavins. 2003. Technological change and the environment. In *Handbook of Environmental Economics*, ed. K.-G. Maler and J.R. Vincent. Amsterdam: North-Holland.
- Jäger, J. 2009. *Our Planet: How Much More Can Earth Take?* London: Haus Publishing.
- National Research Council (NRC). 2005. *Valuing ecosystem services: Toward better environmental decision-making*. Washington, DC: National Academies Press.



- National Research Council (NRC). 2008. *Minerals, Critical Minerals, and the U.S. Economy*. Washington, DC: National Academies Press.
- Niemeyer, S. and C.L. Spash, C.L. 2001. Environmental valuation analysis, public deliberation, and their pragmatic syntheses: a critical appraisal. *Environment and Planning C: Government and Policy* 19(4): 567-585.
- Nelson, E.S. Polasky, D.J. Lewis, A.J. Plantinga, E. Lonsdorf, D. White, D. Bael, and J.J. Lawler. 2008. Efficiency of incentives to jointly increase carbon sequestration and species conservation on a landscape. *Proceedings of the National Academy of Sciences* 105: 9471-9476.
- Nelson, E., G. Mendoza, J. Regetz, S. Polasky, H. Tallis, D.R. Cameron, K.M.A. Chan, G. Daily, J. Goldstein, P. Kareiva, E. Lonsdorf, R. Naidoo, T.H. Ricketts, and M.R. Shaw. 2009. Modeling multiple ecosystem services, biodiversity conservation, commodity production, and tradeoffs at landscape scales. *Frontiers in Ecology and the Environment* 7(1): 4-11.
- Nordhaus, W.D. and J.G. Boyer. 2000. *Warming the World: Economic Models of Global Warming*. Cambridge, MA: MIT Press.
- Princen, T., M. Maniates, and K. Conca (eds.). 2002. *Confronting Consumption*. Cambridge, MA: MIT Press.
- Rabin, M. 1998. Psychology and economics. *Journal of Economic Literature* 36 (1): 11-46.
- Rey, S.J. and M.V. Janikas. 2006. STARS: Space-time analysis of regional systems. *Geographical Analysis* 38: 67-86.
- Rotmans, J., D. Loorbach, and R. Kemp. 2007. Transition management: Its origin, evolution and critique. Paper prepared for the Workshop on "Politics and governance in sustainable socio-technical transitions," 19-21 September 2007, Schloss Blankensee, Berlin, Germany.
- Sachs, W. and T. Santarius. 2007. *Fair Future: Resource Conflicts, Security and Global Justice*. Black Point, NS: Fernwood Publishing Company.
- Stevenson, B. and J. Wolfers. 2008. Economic growth and subjective well-being: Reassessing the Easterlin Paradox. *Brookings Papers on Economic Activity*.
- Spash, C.L. 2007. Deliberative monetary valuation (DMV): Issues in combining economic and political processes to value environmental change. *Ecological Economics* 63(4): 690-699.
- Tilman, D., K. Cassman, P. Matson, R. Naylor and S. Polasky. 2002. Agricultural sustainability and the costs and benefits of intensive production practices. *Nature* 418: 671-677.
- US EPA. 2009. *Valuing the Protection of Ecological Systems and Services*. EPA-SAB-09-012. Washington, DC: US EPA.

- Watts, D.J. 2002. A simple model of information cascades on random networks. *Proceedings of the National Academy of Science* 99: 5766-5771.
- Watts, D.J., and P.S. Dodds. 2009. Threshold models of social influence processes. In *Oxford Handbook of Analytical Sociology*, ed. P. Hedstrom and P.S. Bearman, 475-497. Oxford, UK: Oxford University Press.
- World Bank. 2009. *Global Economic Prospects 2009*. Available from: [http://siteresources.worldbank.org/INTGEP2009/Resources/10363\\_WebPDF-01Chapter1-w47.pdf](http://siteresources.worldbank.org/INTGEP2009/Resources/10363_WebPDF-01Chapter1-w47.pdf) (accessed 12/5/09).
- Wu, J. 2004. Effects of changing scale on landscape pattern analysis: scaling relations. *Landscape Ecology* 19: 125-138.

## Working Group II: Human-Environment Systems (HES) as Complex Adaptive Systems

*J. Marty Anderies, Arun Agrawal, John Crittenden, Ann P. Kinzig, Simon A. Levin, Jianguo Liu, Samuel George Philander, Katharine R.E. Sims, Mary Lou Zeeman*

### Charge to the Working Group

This workshop focused on the dynamics, both endogenous and in response to outside disturbance, of coupled HES (intersection of the lower two circles of Fig. 3, Clark, 2009). Clark (2009) notes that key questions regarding the dynamics of HESs relate to the ways in which their behaviors emerge from adaptive actions by their constituent agents, interacting across multiple scales. Addressing such questions will, as Levin (2009) notes, require new theories that must merge holistic and reductionistic perspectives, integrate physical, social, and biological sciences, and scale from the genomic to the biosphere. Levin further notes that “societies are complex adaptive systems, composed of individual agents who have their own priorities, and who value the macroscopic features of their societies differently. Resolving those competing perspectives is at the core of addressing sustainability.” The charge for Working Group 2: “Human-environment systems (HES) as complex adaptive systems” was to develop research themes and related questions that focus on integrating advances in the theory and modeling of complex adaptive systems (CAS) with rich empirical work on the actual dynamics of coupled HES and to explore the relevance of new tools in CAS research for addressing their interactions.

### Introduction

Given a broad framework identifying key components of sustainability and HESs, (Fig. 3, Clark, 2009) an important next step is to develop tools to understand the dynamics of HESs. A key feature of many HES's, and one of particular relevance for sustainability, is the frequent “disconnect” between lower-level processes (e.g., individual decisions, localized nutrient cycling) and the unintended, system-level patterns and feedbacks these processes can create. For example, individuals make decisions in terms of gallons, pounds, and ounces on hourly time scales. The aggregate flows these decisions generate amount to, for example, 3 gigatons of material used in the US economy that affect resource stocks on decadal time scales and approximately 7 gigatons of carbon released globally into the atmosphere annually, affecting climate on time-scales of decades to centuries. In this case, “milliton” decisions lead to gigaton problems. Achieving a sustainable anthroposphere requires that processes that occur on such disparate scales be somehow connected. Tools to address such problems are desperately needed.

One promising research area that may contribute to this toolbox is that of complex systems and related methods and theories concerning a special class of complex systems: complex adaptive systems (CAS). CAS are defined by several key features that are core to addressing the challenges mentioned above. CAS are composed of agents that interact locally in time and space based on information they use to respond to their environments.

Macroscopic behaviors emerge from these local interactions and are not imposed or predetermined. Agents (at least some agents) have the capacity to process information and modify (adapt) their behavioral strategies. Finally, CAS dynamics are often unpredictable (even if the system is deterministic), and uncertainty is pervasive. As Working Group 4 notes, the scale and richness of constraints and multiple goals of sustainability problems pushes the boundaries of current optimization and constraint methods and a deeper understanding of the underlying structural aspects of sustainability problems is critical. The CAS approach focuses on uncovering such underlying structure and would complement research in stochastic and more complex decision theoretic models and new agent-based optimization systems as proposed by Working Group 4.

The links between CAS and HES are obvious and there is a range of important questions that can be addressed regarding how the underlying structure of interactions among agents within and across social and ecological domains affect the dynamics of the (HES) of which they are component parts. There are a number of stylized facts that have emerged from the study of complex systems in particular and dynamical systems more generally that are clearly relevant for sustainability science: emergent properties that may increase or reduce vulnerabilities across temporal and spatial scales; non-linearities that generate threshold and hysteretic effects and give rise to irreversibilities; and the importance of interactions across spatial and temporal scales (e.g. fast and slow variables in ecological, political, and decision-making processes). However, it is important to recognize some of the limitations of CAS representations of HESs. In particular, HESs are only a subset of CAS, and the behavior of this class of CAS may differ from other classes of complex adaptive systems. In particular, human agents in HES's are capable of foresight (with varying degrees of accuracy), and such foresight alters the stability of systems and other aggregate properties. In addition, the subset of CAS that contain HESs may be characterized by some cross-scale interactions that differ from those in other CAS. The main message for sustainability from the CAS perspective seems to be the ubiquity of unintended consequences (even if the system is perfectly understood) of policy actions and local decisions and the need to carefully connect processes across scales.

Cities, where about 50% of the world's population and 80% of the US population live (UNEP, 2005), provide an excellent example of HESs that have CAS characteristics. Cities are emergent features that result when agents interact to create different types of interdependent infrastructure including engineered structures, information processing technology, institutions and social organizations (laws, norms, policing, legislatures, universities) that all condition in some way the interactions between agents, and their environments. These interactions lead to important macroscopic features of cities and their hinterlands. Urban areas occupy only 2% of the earth's surface pull in huge amounts of resources and export large amounts of wastes (UNEP 2005). Understanding how infrastructure (which sets the rules of the game) in these particular CAS affects their dynamics is obviously critical in the battle for sustainable development. Because they are CAS, choices about the nature of infrastructure in urban areas, as pointed out above, can have unpredictable, unintended consequences.

In addition to helping decision makers recognize the importance of acknowledging unpredictable, unintended consequences, tools based on complex systems science may help more directly in producing infrastructure to address sustainability challenges. Using the city as an example of a CAS, research in complex systems may contribute to developing a robust blueprint for infrastructure by: 1. Understanding and predicting the emergent properties of urban infrastructure (e.g., material and energy use, transportation patterns, urban health implications, heat island, land use and density, air quality, local, regional and global impacts of resource demands and waste generation) and their resilience to stressors (e.g., climate change, natural hazards, fiscal constraints); 2. Identifying how the flows of resources (information, energy, and materials) are utilized within complex urban systems (urban metabolism), and approaches to reduce material and energy demands by learning how these resources are utilized on a system-wide scale; 3. Using the cyberinfrastructure to gather information, to monitor, to model and to visualize the complex evolving properties of urban infrastructure systems; 4. Integrating the human perspective (livability, social interactions, sense of community, open space) into urban infrastructure to produce socially sustainable outcomes and policies; and 5. Developing the pedagogy of complex systems in the context of sustainable and resilient urban infrastructure. Through this adaptive process, we will be helping to plan the infrastructure road map and creating the infrastructure that is needed to design, build, and operate modern, sustainable, and resilient urban systems.

Although, in principle, the discussion of general sustainability problems, and those of cities in particular make clear how a CAS perspective could contribute to the sustainability discourse, it is not so clear how to proceed in practice. Many of the phenomena listed above have been discovered using very simple models. Applying these concepts to actual systems for policy choices that have actual welfare implications is another matter entirely. This report represents an effort to articulate what is required to take the CAS perspective beyond very simple models and move our understanding to the level required to inform the sustainability debate, possibly contribute to policy development, and possibly help develop mechanisms to articulate the relationship between scientific and governance activities.

## **Research Themes**

- A. Characterizing and understanding complex HESs.
- B. Local adaptive responses and their global consequences.
- C. Characterizing tradeoffs in HESs.

## **Unpacking the Themes and Articulating a Research Agenda**

The concept of CAS is extremely broad and incorporates a huge class of dynamical systems. As such, some sort of framework is required to systematically organize the characteristics of such systems relevant to sustainability science. The four themes below provide a basis for applying CAS thinking in a sustainability context.

### *A. Characterizing and Understanding Complex HESs.*

There is a need to develop both a typology of classes of HESs and a typology of emergent properties that are important to HESs. Developing a typology of HESs requires that the question of *What are useful, insightful, relevant model systems to help understand HESs in general, and HESs that exhibit CAS properties in particular* be addressed. Useful, insightful, and relevant can be interpreted in terms of the use of model systems to understand and to act. Identifying relevant model systems may involve questions about how best to aggregate across agents and scales (temporal, spatial, and organizational). Developing a typology of emergent properties requires a *Characterization of macroscopic and emergent properties and their relationship to sustainable development/transitions to sustainability*. Given these typologies, a key research question remains: *What is the mapping between the typology of HESs and the typology of macroscopic and emergent properties?* This mapping will help identify relationships between the underlying structure and processes that define HESs, and the *emergent and macroscopic properties* to which they give rise. The hope is that these typologies and the mapping between them will help identify smaller classes of HESs and qualitative behaviors relevant to sustainability questions – i.e. identify a “few sizes that fit most.” Given the extreme cost of developing “perfect” understanding of the behavior of HESs, how can we use general understanding and principles generated by complex systems research coupled with the typologies and associated mapping to a. identify key points of intervention in complex systems, and b. identify early warning indicators of change?

#### *Research Questions*

While there has been a lot of interest in CAS in the last 20 years, very little work has been done to systematically characterize features of complex systems relevant to sustainability questions. In many HESs, actions of agents and/or processes at one level or part of the system generate surprises, emergent properties, and unpredictable outcomes at other levels or in other part of the system. A deeper, more systematic understanding of emergent behavior in HESs is crucial to understanding how such systems can enhance sustainable development outcomes. In common-pool resource systems such as fisheries, harvesting by individual households not only affects the distribution and patterns of equity among fisher communities that depend on the resource system, it also influences the attributes and components of biodiversity in the resource system. Individual farmer choices to mechanize agriculture in semi-arid landscapes have the potential to influence desertification. Liberalization of food markets and removal of price-setting policies in agricultural commodity markets in many developing countries has enhanced the growth of private investments that have allowed farmers to market their crops more profitably, in turn influencing levels of hunger and farm productivity.

Some human-environmental systems are far more robust to external shocks than others. Village-level agricultural systems in rural India were referred to as “village republics” because of their capacity to withstand change despite major transformations in the macro-polity. Other HESs may be more susceptible to external influences. The degree to which

human environmental systems change in response to external influences depends both on the extent to which they are integrated with ongoing social and ecological processes in their contexts and their own configuration. HESs that are near thresholds and are tightly integrated may be quite susceptible to change and phase shifts. Many small to medium-sized cities in different parts of the developing world are undergoing major transformations in their size, spatial structure, and public services depending on the extent to which they are served by a transportation infrastructure and the levels of economic investment within the city. Understanding the characteristics of HES that make them robust to internal vs. external changes is likely to be instrumental in facilitating better sustainable development outcomes in them.

Even if aware of the potential for thresholds or tipping points behavior in HESs (Scheffer et al. 2009, Liu et al. 2007), in most cases the existence of thresholds is largely unknown. If thresholds are known to exist, their locations are often unknown. Detecting thresholds is a very challenging task because they often occur at one point along a large gradient, but data may not be available at the threshold point even if available at many points along the gradient. Further, the gradients themselves can change over time. There may be early-warning signs near thresholds (Scheffer et al. 2009), but detection of early-warning signs is data intensive (costly). Furthermore, models are usually not good enough to tell where/when thresholds may occur (Scheffer et al. 2009).

Little work has been done on what combinations of characteristics of HES lead to patterns of qualitative system behavior that are critical to sustainability questions such as what characteristics might make HESs 1. robust to both internal and external shocks, 2. susceptible to both, or 3. robust to external shocks but receptive to internal perturbations and *vice versa*. What characteristics lead to thresholds that may generate more intractable irreversibilities in a system? Likewise, when we engineer complex systems, we want to preclude undesirable emergent behaviors and generate or exploit desirable ones. We lack the knowledge to systematically predict these behaviors based upon system structure or design or the attributes of small-scale components. In order to build the requisite knowledge to address these issues, several interrelated questions need to be addressed:

*1. What kinds of models and model typologies are useful to: a. represent, b. understand, c. predict HES emergent properties and macroscopic behavior?* Here we use both the terms models and model-typologies to emphasize the need for a set of models and a typology used to categorize them, and thus the HESs they represent. We emphasize that classification of HESs requires iteration between modeling and the development of typologies. Examples of HESs that provide motivation for model development (model systems for sustainability science in the sense of drosophila population dynamics as a model system for evolution) include common pool resource systems (fisheries, forestry); urban networks in poor countries; urban form, hydrology and land use; the global energy system; and regional pollution control. Combining agent-based models (An et al. 2005) with traditional dynamical systems approaches is a particularly promising way forward to understand the interactions among agents and the resulting emergent properties.

As described in Guckenheimer and Ottino (2008), instead of a single model that captures the essence of complex HES behavior (likely to be an unrealistic goal), we may want a hierarchy of models to capture the key behaviors. Identifying the appropriate scales and the units for model components is one of the critical challenges for complex systems research. Formulating a model that is too complicated to analyze or simulate accurately may yield little useful information, but models that are too coarse to produce the behavior of interest are also inadequate. Likewise, what are the appropriate typologies to usefully group models within this hierarchy?

*2. Typology of behavior and structure.* How do macroscopic and emergent properties of HES come into being, how are they sustained and how do they feedback among different levels of aggregation? Are there ways of classifying emergent properties in HES that are important and relevant for improved sustainable development outcomes? How does the structure of an HES constrain its emergent behaviors? Can the typology of emergent properties provide diagnostic tools for underlying structural properties and mechanisms to promote sustainability transitions? What structural or behavioral characteristics of CAS make them robust/receptive to external shocks or internal perturbations – i.e. what behavioral characteristics make CAS sustainable in the face of uncertainty and change?

*3. Transitions between states.* How do we evaluate sustainable development at each state and what are motivations for making the transition between states (cf. Working Group A)? What are the trade-offs between short-term and long-term consequences of each trajectory and each state? What are possible mechanisms for endogenous or exogenous, intentionally or unintentionally generated sustainability transitions? What are possible opportunities for transitions and indicators of those opportunities? Which HESs lead to the most intractable thresholds, irreversibilities. What are early indicators of those thresholds?

*4. Innovation.* How can innovations be characterized in HES? How do innovations by agents in the system affect or respond to emergent properties? How do different kinds of innovations in component subsystems interact? How does innovation enhance transition or resilience? How do we foster innovation as a transition strategy?

Understanding derived from answering these 4 sets of general questions can then be used to address a more applied set of questions. Specifically, there are a myriad HESs in the world – some connected to each other in nested hierarchies, others interacting directly or indirectly in more complicated networks. Each, on the face of it, appears unique, resisting any “one size fits all” understanding of dynamics or recommendations for interventions to promote sustainability transitions. However if such complexity resists a set of “one size fits all” prescriptions or understandings, we must either deal with each unique case (unlikely) or search for some generalities, i.e. search for a set of “few sizes fit most” characterizations. In other words, based on answers to the questions above, can HESs be classified into a handful of “typologies”, sharing similar structures, dominant microscopic processes, emergent patterns, and non-linear behaviors which can be used to understand: a. the most intractable (dangerous, irreversible) thresholds operating in systems of certain types, and the best strategies for detecting and avoiding them; b. the



“positive” thresholds that allow transformation to a more sustainable HES, and the timing and placement of interventions that would facilitate that transformation; c. the ways in which short-term and localized decisions constrain or facilitate long-term sustainable development, or influence distant (in space or time) HESs; d. the difficult decisions or environment-development trade-offs that exist and will persist even after transformations have been achieved, and e. the costs and benefits of adaptation and/or innovation in coping with change.

### ***B. Local Adaptive Responses and their Global Consequences.***

A fundamental characteristic of many CAS is that agents rely on local (in time and space) information, fundamental aspects of system structure, and memory to make decisions and cope with change. This is in stark contrast to making decisions based on predicting a range of distant future outcomes (based on an assumed (imperfect) understanding of global dynamics), weighting these outcomes across agents, space, and time and choosing the “best” one. Humans have a limited capacity to predict global dynamics well, and recognize that decision makers will continue to make decisions on localized (e.g., nation-state) and short-term scales that don’t fully account for global sustainability outcomes. Thus, CAS seem a compelling tool for learning how localized decision-making may lead to larger-scale properties that can be either desirable or undesirable, sustainable or unsustainable. An understanding of the relationship between local adaptive responses and their global consequences is crucial to the practical application of CAS in the policy and sustainability science arena.

### *Research Questions*

Human societies are complex adaptive systems, composed of individual agents who have their own priorities, and who value the macroscopic features of their societies differently. Societies are component parts of larger classes of complex adaptive systems: coupled HESs. The environmental component of HESs is also composed of a large number of individual agents each interacting with their environment in a different way. Note that we interpret “agent” very broadly to include chemical agents and, with them, the geochemical and geophysical environments they generate. None of the agents, due simply to the sheer complexity of the system, has access to all information in the system. They must, therefore make decisions (or affect responses) based on local (in space and time) information. Given selective pressures, either natural or due to human choice processes, organisms (e.g. behavior/physiology, etc.) and structural components of the system (institutions – rules of interaction, forms of social organization, etc.) may become well adapted to local conditions. In the process of adapting, agents impact the system itself, and thus its macroscopic properties. It is interesting to note that HESs may deviate from “pure” CAS in that humans do try to gather “global” (at least larger-scale) information and, through the use of models to forecast, try to expand the temporal scales used to make decisions. A very important question is how the existence of some agents who expand the scale of the information they use to make decisions affects the dynamics of the CAS in which they are embedded. Can a small number of such agents so influence the dynamics of the system that it ceases to exhibit CAS?

It is frequently the case that small-scale HESs suppress variation at particular temporal and spatial scales. Often this is achieved via infrastructure that enables a group to integrate or smooth variation in space or time. Irrigation HESs, which act to suppress inter-annual variation in water availability, are quintessential examples and illustrate local-global trade-offs. Specifically, irrigation systems are comprised of infrastructure (canals, flow controls, rules and social mechanisms to coordinate activity) to capture water for rivers and direct it to land. The water volume in the river, of course, results from the spatial integration over its watershed. Thus the irrigation system connects a much larger area to a smaller area and connects processes at two different scales (at least) in order to suppress variation. In becoming adapted to this hydrological context, the irrigation system (infrastructure plus people who operate and benefit from it) becomes vulnerable to other types of variation and disturbance such as coordination problems, distribution problems (free-riding), costs in terms of social control, and vulnerability to low frequency shocks (50- or 100-year floods).

Another example is an exchange system – a very important and basic structure in social systems. An example is the !Kung Hxaro exchange network. !Kung households engage in ritualized exchange with specific partners, called Hxaro partners that they inherit, in part. Typically, hxaro partners live in different settlements. Through ritual exchange, hxaro partners “store up” trust and reciprocity through ritualized exchange of gift items (often beautifully and painstakingly hand-crafted). The stored reciprocity is exercised when conditions are poor (drought) in one partners region and they leave to live with their exchange partner in another region where conditions are better. The infrastructure of the hxaro exchange system then allows households to move to the resource (in contrast to irrigation systems which move the resource to the households) and reduces variability by, again, averaging resource availability over space. What is important here is that the hxaro exchange system involves a significant robustness-performance tradeoff. The !Kung spend about 15 hours per week to feed themselves. They spend a significant amount of time – 25 or more hours per week on making gifts for exchange and monitoring reciprocal relationships. Specifically, reducing variability involves significant opportunity costs in terms of leisure time. Further, it generates a social structure that may affect broader-scale properties by linking landscape patches.

At present, we lack a systematic methodology to understand in more general terms the sustainability implications of the interrelationships between agents, the structures they create that link agents, patches, and scales that are evident in the examples above. The key research questions under this theme focus on understanding the details of the characteristics of agents, the relationship between the structures they create through local adaptation processes and global properties of the system. Understanding of these relationships can then be used to navigate trade-offs between aspects of both local adaptation and its global consequences that are deemed either desirable or undesirable. There are three questions related to this issue:

*1. How do mechanisms that allow HES to adapt to short-term change affect their capacity to solve other types of problems?* That is, how do structures aimed at coping with higher frequency variation (e.g. annual) affect issues such as resource distribution,

power relationships, personal freedoms, capacity to learn and cope with long-term change (e.g. decadal or centuries) that are so critical to maintaining human wellbeing in the long term?

2. *Given that structures in HESs may evolve to link systems across scales, how do shocks, both desirable and undesirable, cascade through HES?* An example of an undesirable shock is the cascading failure of a power grid. An example of a positive shock is when individual action causes synergies that align different groups of actors that would never otherwise be aligned. The impact of Majora Carter through the Sustainable South Bronx project aligned actors in the educational, social justice, environmental, green energy, and green building arenas that induced astonishing change. Adaptive process within HES can also link them to other HESs. This may give rise to contagion processes or what has been referred to as “systemic risk” where actors individually engage in contracts to reduce their risk that lead to increased risk at the system scale.

3. *Are there general features of CAS that tend to suppress variation at particular frequencies/scales that, especially in the case of HES, lead to particular efficiency/robustness (performance) trade-offs?* This is a question of our capacity to identify patterns that ultimately emerge from a multiplicity of microscopic interactions that are sufficiently robust to imply that they are independent of many of the details of those interactions, or of the characteristics of the particular agents that populate the HES. We then must characterize particular classes of tradeoffs across temporal and spatial scales and between robustness and performance related to these robust patterns. Policy, action, or structures within HES directed at enhancing human wellbeing (a performance measure) necessarily involve tradeoffs – e.g. simplifying biological communities that provide life support systems and, in turn, reducing their capacity to cope with change (loss of robustness). Understanding of these relationships may enable us to influence system structure through institutions that align efficiency robustness and dynamics at different spatial and temporal scales in ways that are more desirable from a sustainability perspective. Work on such robustness-vulnerability tradeoffs begun in engineering by Bode in the 1940’s has been recently extended by John Doyle and others to ecological systems (Carlson and Doyle, 2002). Anderies et al. (2007) have applied ideas from robust control to explore robustness, vulnerability, and performance trade-offs in detail in a resource management and sustainability science context.

These questions are closely related to classic questions in environmental and resource economics relating to the problems of collective action and inter-temporal resource allocation. Problems of collective action relate to the fact that individuals make decisions based on individual cost and benefit considerations without considering the costs and benefits their decisions may have for others in society. In the language of CAS, individuals make decisions based on local information that lead to emergent phenomena at the global (=societal) scale that can be negative (too much pollution, over exploitation of resources, etc.). Inter-temporal resource allocation relates to the fact that individuals make decisions locally in time (short time horizon or, equivalently, applying a high discount rate), without considering the long-term (global) consequences of these decisions. What then, does the CAS approach offer other than different language to

describe existing ideas? We suggest that a vigorous research program that adopts a CAS perspective would broaden the classes of possible dynamics and solutions considered in dealing with these problems. Traditional methods in economics have considered a fairly narrow range of institutional arrangements (government regulation, taxes, property rights) within a very narrow range of social and political contexts, within a very small subset of possible environmental dynamics, with a narrowly defined welfare objective (maximize some measure of social welfare), and with a narrowly defined conception of uncertainty. A CAS approach would emphasize a drastic broadening of the possibilities from each of these classes of relevant HES characteristics, and would focus on developing tools to analyze this much broader class of models. Thus, a CAS approach would ask not “what is the optimal tax to regulate a particular form of pollution?” but rather “what classes of institutions are effective in more closely aligning long-term and short-term interests and global (societal) and local (individual) interests for given classes of HESs characterized by given classes of uncertainty.”

### *C. Characterizing Tradeoffs in HESs.*

“Trade-offs” are an inherent feature of CAS – not all desirable macroscopic properties or microscopic processes can be simultaneously realized. This will be true even were the world to achieve a “transition” to sustainability – limited resources would dictate having to select among various environment and development goals. Thus, environment-development (efficiency/performance) tradeoffs, tradeoffs among different ecosystem attributes (services/outcomes) and tradeoffs among different development outcomes will have to be made. Understanding these trade-offs is critical to producing better sustainability outcomes.

#### *Research Questions*

In order to make informed decisions concerning meeting human needs while maintaining critical life support systems over the long term, policymakers need a comprehensive understanding of the tradeoffs inherent in complex adaptive human-environment systems. A key goal of sustainability science is to facilitate the transition from current human-environment systems to configurations that are richer in attributes which society values: better health, greater education, healthy ecosystems, greater biodiversity, etc. However, human-environment systems are likely to be fundamentally constrained in their ability to deliver multiple desirable outcomes simultaneously.

Although win-win solutions may be possible in some circumstances, there is adequate evidence of important real world tradeoffs inherent in human-environment systems (Naidoo et al. 2008, Liu et al. 2007, Nelson et al. 2008). Certain configurations of landscape systems may increase short-term food production but at the same time decrease resistance to pests or biodiversity. Reconfiguring the world's energy systems in favor of low carbon alternatives may mitigate climate change but this choice will likely make food and energy more expensive in the short term. Encouraging regional diversity in air pollution control systems may encourage creative local innovation but could increase administrative costs or lead to a dangerous race to the bottom in regulations. Similar

tradeoffs confront the would-be managers of many human-environment systems: in most cases there is no system architecture that can optimize all desired sustainable development outcomes in human-environment systems.

An important role of sustainability science therefore is to shed light on the nature of such tradeoffs. Although there is work from individual disciplines describing and quantifying specific examples of tradeoffs, these have focused primarily on tradeoffs within human systems or within environment systems. More research is needed that understands how tradeoffs emerge in *integrated* human-environment systems. Understanding how vital sustainability outcomes depend on patterns and processes of joint human-environment systems has been identified as a key research goal for sustainability science (Naidoo et al. 2008, Carpenter et al. 2009, Matson 2009).

As discussed above, the CAS perspective may be useful in explaining how individually optimal actions can lead to sets of macroscopic patterns which will likely not be optimal. However, much of the previous work in complex systems is primarily theoretical (Liu et al. 2007). Most existing empirical work focuses on environmental systems (Levin 1998) or human systems (May et al. 2008). Existing empirical work on coupled human-environment systems draws attention to important properties of complex adaptive systems (Liu et al. 2007) but does not explicitly characterize tradeoffs. Patterns of qualitative and quantitative tradeoffs in human-environment systems have not been adequately considered in previous research. This is a question of the utmost urgency for policymakers concerned with sustainable development.

What are the major tradeoffs inherent in human-environment systems and how do these tradeoffs depend on the patterns, processes, and structures of the system? Which are persistent, and which can be reduced or eliminated?

1. Which tradeoffs (between development goals, different aspects of environmental quality, or between environment and development) are persistent or pervasive across different types (classifications) of adaptively complex human environment systems? Which change in predictable ways as systems develop or go through transitions?
2. Which tradeoffs are amenable to reduction or elimination through institutional, socioeconomic, or technological innovation?
3. What types of international institutions are required to navigate tradeoffs that currently fall outside of national or regional jurisdictions? How could these institutions facilitate international collective action or cooperation? How can such collective action fairly recognize different perspectives (aggregate different or competing preferences) to achieve more sustainable outcomes?
4. Under what circumstances does a complex adaptive systems perspective help us to better understand tradeoffs – how and where they arise, and how they differ and are resolved across scales of space, time, and social organization?

We note that there is an important issue that is relevant to all four of these questions. This is the idea that human utility structure is likely not well represented by smooth trade-offs or similar weightings for all levels of goods and services. For example, trade-offs such as between eating more food or going out for an evening of entertainment is far more “sharp” when one is near the poverty line and nutritionally stressed than when one is wealthy. Put simply: some tradeoffs are more important than others. Further, although decision problems based on maximizing utility might suggest that a certain resource allocation is suboptimal and increasing consumption of a particular good or service could move the decision maker to the optimal, the increase in utility may be small, while the increase in consumption may be enormous. Robert Frank (1999) has pointed out the pernicious nature of this “flat of the curve problem” in his work on luxury fever – i.e. how much more happiness does a 60,000 square foot home provide over a 2,000 square foot home? Not much, but the dynamics of the system still drives house sizes up, to the disbenefit of a great number of individuals in society.

## **Disciplines and Methods Required**

Current empirical and theoretical work on human-environment systems has drawn from a variety of disciplines, as illustrated by the involvement of researchers with expertise in ecology, economics, sociology, demography, geography, anthropology, political science, remote sensing, mathematics, limnology, and computer science in the current CHANS (coupled human and natural systems) program by NSF ([www.chans-net.org](http://www.chans-net.org)). We expect that efforts by sustainability science to understand complex human-environment systems will similarly draw on a diverse set of disciplines.

A central challenge is to integrate advances in the theory and modeling of complex adaptive systems with empirical work on actual dynamics of real world human environment systems. This will require not just the marriage of existing empirical and theoretical work but also the collection of new data sets and the development of theories more specific to integrated systems.

## **Final Remarks and Cross-Group Questions**

The focus of this report has been on the role that complex adaptive systems may play as tools for understanding and characterizing HESs in order to contribute to the decision-making and policy making processes. A widely recognized problem in the use of scientific results for decision support and decision making is that we need better and more systematic analyses of the decision process itself, i.e. what does the word “*contribute*” mean, in the statement above. We need to know how sensible policy decisions about sustainability problems may be made when such decisions must take into account possible conflicts and risks among their outcomes, differences in their costs, differences in the times in which they can be accomplished, and uncertainties in the information that enters into them. And we need to know how scientific information can most effectively be incorporated in this process. These recommendations fall outside the charge to our working group, but we feel they are important to include. The final plenary

discussion illustrated that they interact with similar recommendations emerging from several of the working groups.

### *Decision Making as Social Choice*

From the decision-maker's point of view, decision-making is a problem of social choice. Despite an extensive literature on voting and social choice, the field is still only in a nascent stage when it comes to understanding decision making outside the legislative contexts of advanced industrial countries and democratic processes. Indeed, far more work on the relationship between decision choices under different conditions and constituent preferences is needed. Working group 4 deals with this issue as part of a research agenda concerning Knowledge systems for Sustainable Development, we highlight some questions from a less applied, more theoretical CAS (interacting agents and rules) perspective.

1. What are the institutional mechanisms (rules) that allow the content of scientific discoveries to play a role in the manifestation of decision choices?
2. What forms of analysis provide most effective insight into how the decision choices interact with the parameters of a human-environment system?
3. What forms of communication between scientists and decision makers are most effective at informing the decision choices?
4. What are the social and community norms that frame, and possibly inhibit, effective decision support.
5. How are decision made when information about constituent choices is limited or non-existent, and/or the context is one of bureaucratic or judicial decision making rather than legislative decision making

### *Dynamic Decision Support*

The time scale of decision-making for HES is typically longer than the time scale of individual decision makers. Decisions about HES should not be one-time decisions, but part of a dynamic mechanism of decision-making, information feedback about the consequences of each decision, and corrections to the decisions. We need to know how decisions may best be changed in light of outcomes and changing circumstances.

1. How does voting (decision making) behavior change when dynamic feedback is included?
2. By what mechanism, and on what time-scale, can the consequences of HES decisions be monitored?
3. As above, what is the most effective form of analysis and communication of the consequences of previous decisions for informing the next decision?

## References

- Anderies, J.M, A. Rodriguez, M. Janssen, and O. Cifdaloz. 2007. Panaceas, uncertainty, and the robust control framework in sustainability science. *Proceedings of the National Academy of Sciences* 104(39): 15194-15199.
- An, L., M. Linderman, A. Shortridge, J. Qi, and J. Liu. 2005. Exploring complexity in a human-environment system: An agent-based spatial model for multidisciplinary and multiscale Integration. *Annals of the Association of American Geographers* 95: 54-79.
- Carlson, J. and J. Doyle. 2002. Complexity and robustness. *Proceedings of the National Academy of Sciences* 99: 2538-2545.
- Carpenter S.R., H.A. Mooney, J. Agard, D. Capistrano, R. DeFries, S. Diaz, T. Dietz, A. Duriappah, A. Oteng-Yeboah, HM Pereira, C. Perrings, WV Reid, J. Sarukhan, RJ Scholes, and A. Whyte. 2009. Science for managing ecosystem services: Beyond the Millennium Ecosystem Assessment. *Proceedings of the National Academy of Sciences* 106: 1305-1312.
- Clark, W.C. 2009. Sustainable development and sustainability science. Background paper, *Toward a Science of Sustainability Conference*, November 29-December 2, 2009.
- Frank, R. 1999. *Luxury Fever*. Princeton, NJ: Princeton University Press.
- Guckenheimer, J. and J.M. Ottino. 2008. *Foundations for Complex Systems Research in the Physical Sciences and Engineering*. NSF Report.
- Levin, S.A. 1998. Ecosystems and the biosphere as complex adaptive systems. *Ecosystems* 1: 431-436.
- Levin, S. 2009. Complex adaptive systems and the challenge of sustainability. Background paper, *Toward a Science of Sustainability Conference*, November 29-December 2, 2009.
- Liu, J., T. Dietz, S. Carpenter, M. Alberti, C. Folke, E. Moran, A. Pell, P. Deadman, T. Kratz, J. Lubchenco, E. Ostrom, Z. Ouyang, W. Provencher, C. Redman, S. Schneider, and W. Taylor. 2007. *Complexity of Coupled Human and Natural Systems*. *Science* 317: 1513-1516.
- Matson, P. 2009. The sustainability transition: What science can do (Additional Background Papers). Additional Reading, *Toward a Science of Sustainability Conference*, November 29-December 2, 2009.



- May, R.M., S.A. Levin, and G. Sugihara. 2008. Ecology for bankers. *Nature* 451: 893-895.
- Nelson, E., S. Polasky, D.J. Lewis, A.J. Plantinga, E. Lonsdorf, D. White, D. Bael, and J.J. Lawler. 2008. Efficiency of incentives to jointly increase carbon sequestration and species conservation on a landscape. *Proceedings of the National Academy of Sciences* 105: 9471-9476.
- Naidoo, R., A. Balmford, R. Costanza, B. Fisher, R. E. Green, B. Lehner, T. R. Malcolm, and T. H. Ricketts. 2008. Global mapping of ecosystem services and conservation priorities. *Proceedings of the National Academy of Sciences* 105:9495-9500.
- Scheffer, M., J. Bascompte, W.A. Brock, V. Brovkin, S.R. Carpenter, V. Dakos, H. Held, E.H. van Nes, M. Rietkerk, and G. Sugihara. 2009. Early-warning signals for critical transitions. *Nature* 461: 53-59.
- United Nations Environment Programme. 2005. *Press Release: "One Planet Many People Atlas" Launched to Mark World Environment Day 2005*. Available from: [http://na.unep.net/OnePlanetManyPeople/press\\_release.html](http://na.unep.net/OnePlanetManyPeople/press_release.html).

## Working Group III: Measuring and Monitoring Progress Toward Sustainability

*Krister P. Andersson, Stephen R. Carpenter, Jeannine Cavender-Bares, Jonathan Foley, John Guckenheimer, Shaleen Jain, Robert W. Kates, Veerabhadran Ramanathan, Jessika Trancik*

### Charge to the Working Group

Development of a science of measuring and monitoring for sustainability is essential for guiding policies and evaluating progress towards improved human well-being and sustenance of the earth's life support systems. Our working group was charged with identifying the major priority areas (research themes) for development of a science of sustainability monitoring and measuring that builds on but goes beyond contemporary approaches. As part of this charge, we were asked to provide a conceptual and methodological framework for sustainability measuring and monitoring that confronts inherent issues of scale, aggregation problems and the need to develop common metrics for sustainability. Specifically, we were tasked with answering the questions: What are the critical research developments necessary for sustainability monitoring and measuring? Why are these important? And, are they feasible?

### Introduction

Measuring and monitoring the transition of society towards a more sustainable future will have to be a cornerstone to any future progress in sustainability science (Levin 2009, Clark 2009). Monitoring is critical for understanding trends in resource stocks and flows (both renewable and non-renewable) and in human well-being. Knowledge of these trends informs decision-making and management, promotes advocacy, participation and consensus building, and aids research and analysis (Parris and Kates 2003). Research on the role of monitoring in global environmental risk management has shown that previous monitoring efforts have been very effective in framing and reframing societal debates, stimulating risk assessments, implementing policy change, and enforcing compliance, whether or not they were designed for this purpose (Jäger et al. 2001). Developing a science of sustainability monitoring and measuring will require long term, spatially distributed empirical data sets to test theories and guide policies of sustainability (Clark 2009). Foundations for monitoring measures and metrics to guide sustainability have been explored in a series of NRC studies (e.g. NRC, 1999a; NRC, 1999b; NRC, 2000), and systematic efforts to document the state of ecosystems and ecosystem services at national and international levels have emerged (Carpenter et al. 2009, H.J. Heinz Center, 2008). The climate change debate is also witness to much discussion about appropriate metrics. While establishment of metrics and data compilation following along the lines of current approaches are necessary for development of a true science of sustainability monitoring and measurement, they are not sufficient. Synthetic efforts for monitoring and measuring that are linked with global and local initiatives and guided by a common sustainability framework remain underdeveloped. Success will require: 1. Identification of key state variables that determine sustainability, 2. Understanding their underlying

determinants, and 3. Identification of key feedbacks that could guide adaptive management (Clark 2009). In pursuit of these goals, theoretical and modeling developments are critical, as well as integration and synthesis of ongoing monitoring and measuring efforts at multiple scales, and establishment of new initiatives in key areas. We present here a research agenda with priority areas (research themes) aimed at development of a true science of measuring and monitoring for a sustainable future.

## **Research Themes**

Four core areas (research themes) are recognized as critical for measuring and monitoring within the framework of sustainability. First, we emphasize the need for a new generation of models specifically designed for the study of sustainable development. These will be critical for prioritizing critical parameters for sustainability, examining past and current trends, and forecasting future scenarios. Second, we consider the metrics, approaches and capacity building necessary for measuring and monitoring whether we are moving towards or away from sustainability. We recommend an initial focus on WEHAB (water, energy, health, agriculture, biodiversity, and other) variables, which may be modified and re-prioritized in part by modeling efforts, and we recognize the need for research linking these to metrics of human well-being. Third, we argue that expanding, enhancing and synthesizing synoptic global data AND creating observation systems to acquire long-term place-based data are both essential. Long-term place-based measuring and monitoring represents the greatest dearth of information for sustainability, and capacity building in this area is critical. Finally, we emphasize the importance of examining fundamental alterations in system dynamics, which may be leading toward or away from sustainability. The capacity to examine transitions, which may be abrupt or gradual, and to develop future scenarios for a sustainability transition depends fundamentally on the availability of long-term data acquired at spatial and temporal scales appropriate to understanding system dynamics.

Research themes summarized:

- A. A new generation of models for the study of sustainable development.
- B. What should be measured and monitored to understand and evaluate our progress towards sustainability and improved human well-being?
- C. Creating, maintaining and using long-term, place-based observations to measure progress toward or movement away from sustainability.
- D. Transitions: towards and away from sustainability.

## **Unpacking the Themes and Articulating a Research Agenda**

### ***A. A New Generation of Models for the Study of Sustainable Development.***

Quantitative studies are necessary to track our movement toward or away from sustainable development. Predictive models are important in evaluating different possible development pathways and establishing goals, and monitoring of key variables is needed to assess progress. Interpretation and understanding of monitoring data rest on

models, and data are essential for many steps in the modeling process. Recent advances in theory, technology and databases are creating remarkable new opportunities to transform the models available for understanding, forecasting and managing changes in human development and environmental sustainability.

A new generation of models designed for sustainability science is needed. Many of the existing models used in sustainability science were developed for other purposes. Often they are scaled inappropriately to incorporate human dynamics and bridge the local and global character of sustainable development. Moreover, many of the existing models are not suitable for analysis of inter-sectoral issues such as food, water, health, carbon, energy, non-renewable resources, and ecosystems, yet sustainable development explicitly requires consideration of how these issues change with time and affect one another.

The new generation of models must build on past successes but make further progress toward understanding unprecedented changes in human-environment systems. Human development is greatly impacted by changes in agricultural production, urbanization, demography, technology and other human activities. At the same time, Earth's basic life support systems have changed more in the past 50 years than at any time in the history of our species (M.A. 2005a). These moving baselines mean that without a detailed understanding of how different components of the system depend on one another, the relationships predicated on the past may not be reliable for forecasting the future. This is particularly challenging because multiple models that explain past data equally well may give very different projections of future scenarios. Therefore questions of model structure uncertainty, tradeoffs of structural and parameter uncertainty, and different characteristics of uncertainty across hierarchies of models become crucial. Careful model formulation combined with new data collection efforts provides a promising pathway toward new fundamental understanding in sustainability science.

The *overarching goal* of this research theme is to accelerate development and appropriate use of models to understand the evolution of food, water, energy, non-renewable resources, and other systems supporting human needs at scales of human action, impact and response.

#### *Research Questions:*

Important topics for research in this area include:

1. *Bridging domains such as food, water, energy, non-renewable resources, etc.* These domains were highlighted because of their impact on human well-being, and because changes in each has an impact on the others (Graedel and van der Voet 2010). For example, models of different energy futures that include substantial reliance on biomass and nuclear fission, must take into account the associated changes in food production capabilities and water use, which in turn may need to take into account adaptive strategies for dealing with these changes. Other energy technologies are associated with different sets of impacts, which may be more or less favorable to human well-being. Similarly, starting with the modeling of food production, one may ask how different historical development trajectories and future scenarios affect energy use and emissions of CO<sub>2</sub>, as well as water consumption. Finally, with further knowledge about the trade-

offs between different impacts, priorities can be evaluated in a sensible way, by soliciting input from a variety of areas around the globe.

*2. Co-evolution of models and monitoring.* Development of models can inform the question of what data we should be collecting to monitor progress toward or away from sustainability. Because of the interaction between components, individual trends cannot be fully interpreted in isolation. Data, in turn, are required to parameterize models. Further work is critically needed in the area of food, water and energy (and other areas of relevance to human well-being) on determining the sensitivity of model outcomes to particular parameters, and using this improved knowledge to influence further data collection. For example, models of climate change mitigation scenarios demonstrate the sensitivity of projections of the cost of mitigation to assumptions about how technologies improve and grow over time (Fisher et al. 2007). This indicates a need for further data collection on the use of resources of all types and on the evolution of technologies.

*3. Validation and relationships among models and data.* Fitting monitoring data to predictions is the most direct method for validation and verification of deterministic models. However, complex system models in the realm of sustainability are often stochastic, so the models produce probability distributions of predictions rather than individual trajectories that can be compared with data. There is a fundamental tradeoff in the models between the complexity of the models (e.g., measured by the numbers of parameters) and our ability to parameterize the models with observational data. This tradeoff extends to the computational demands of simulating the models over comprehensive ranges of the parameter distributions. Research on hierarchies of models and the relationships among them can help improve the reliability of models and our ability to use them effectively.

*4. Assessing and communicating uncertainty.* Assessing the uncertainty of model predictions is an issue that confronts all computer simulation. The uncertainties come in several forms. First, there are the uncertainties that are associated with poorly measured parameters and stochastic components of a model. One aspect of these uncertainties is the possibility of multistability and/or critical transitions in which small changes produce large changes in model behavior. Second, the way in which uncertainty propagates through different subsystems of a model helps us quantify the uncertainty of the final predictions. (In many cases, the output of a subsystem may be insensitive to its inputs.) Third, there are structural uncertainties related to how well the model captures fundamental relationships between the quantities represented in the model. Models inevitably aggregate different entities that may respond differently in the real world. Communicating uncertainty of model predictions is a substantial challenge. Even in the context of daily weather forecasts, there is poor understanding of statements like “40% chance of showers.”

*5. Integrating models and scenarios.* Sustainability science anticipates that the world will change in response in human action, often uncoordinated. Models help us assess the impact of that action and to plan efforts to ameliorate undesirable consequences by simulations of “what-if” scenarios. As an example, we would like to be able to forecast the consequences of differing CO<sub>2</sub> emissions scenarios on global warming and the effects of different levels of global warming on ecosystems and agriculture. The development of

modeling tools that allow non-experts to readily test – and interpret – scenarios is a challenge for the integration of models into policy formation.

These proposed priority areas (research themes) of work are feasible and will build on existing capacities for modeling, and specific models (examples from ecology: Kareiva et al. 2005, Tallis and Kareiva 2006). New capacity must be built as well, for example new collaborative working groups, education and training programs, and outreach to decision makers and the public.

The current state of global, integrated models of human and environmental systems leaves ample room for further improvement. Models that allow us to better understand the evolution of food, water and energy and other systems supporting human needs are critical in part because the costs of continuing on current trajectories are enormous, and better understanding is required for successful intervention. There are inherent limits in our ability to forecast the future, but we are forced to do so in order to intervene. Further efforts in modeling and data collection can greatly increase our chances of success. The approach outlined here departs from that taken by Working Group 2 by focusing on high-level “community” models rather than on complex adaptive systems. Our approach starts from the perspective that sustainability requires adaptation to constraints imposed by resource limitations. Without regulation, many processes are subject to shocks and critical transitions (see Research Theme D). A fundamental challenge, then, is to prevent shocks that will be caused by human activity if we proceed with “business as usual.” This requires models capable of reliably forecasting states and variables under different scenarios.

### ***B. What Should Be Measured and Monitored to Understand and Evaluate Our Progress towards Sustainability and Improved Human Well-Being?***

We recommend that measurement and monitoring systems be designed to focus on the central objectives of sustainability – mainly those connected to simultaneously improving human well-being while preserving the planet’s life support systems – rather than simply relabeling already-existing “environmental” and “social” measurements.

Identifying targets for characterizing and measuring sustainable development involves making choices about how to define and quantify what is being developed, what is being sustained, and for how long. There are many efforts to develop those choices that are outside the scope of our recommendations. We propose, in general, that measurements and monitoring programs focus on a minimum set of variables and parameters, starting with fundamental “WEHAB” sectors (Box 1). These include parameters related to water, energy, health, agriculture, biodiversity, non-renewable resources, and others. We argue that they be informed and prioritized by modeling efforts discussed above. Research is needed to understand better the links between these metrics and metrics of human well-being, as pursued further by Working Group 1. These metrics are not meant to be exclusive, but rather a starting point for common measurement and monitoring strategies.

**Box 1: WEHAB Plus Metrics**

Since 1987, and the publication of the Bruntland Commission Report (WCED 1987), six sectoral challenges to sustainable development have been identified. For the Bruntland Commission, these were population, settlements, agriculture, energy and materials, and living resources. For the U. S. National Academies (NRC 1999a), population, cities, agriculture, industry and energy, and living resources were priorities for action. And in 2002, UN Secretary-General Kofi Annan (2002) proposed for the Johannesburg World Summit on Sustainable Development (WSSD) five key areas for particular focus: Water, Energy, Health, Agriculture and Biodiversity (WEHAB), adding water as it became a larger concern, dropping materials and cities, perhaps inadvertently, and substituting health for population as concern for population shifted from family planning to reproductive health. Today the WEHAB plus Non-Renewable Resources and Cities set is a useful starting point for developing metrics for measuring and monitoring progress towards sustainability. It serves as a measure of the sustainability transition where human needs are met and the life support systems of the earth are preserved. It serves as well to support specific needs for human society and to study potential drivers of life support changes. While useful, a word of caution is needed. As shorthand titles, and as both needs and drivers of change, they can easily omit our enlarged understanding of coupled human-environment (H-E) systems that has emerged since 1987 or 2002. For example, agriculture today represents all aspects associated with production and consumption of food, biomaterials, biofuels, forestry and the like, some of which are not currently monitored by the international agencies. Or even more complex is biodiversity, often used simply as a measure of species richness, but in the broadest sense should refer to the structure and functioning of landscapes and seascapes. For example, it includes heterogeneity of ecosystems on landscapes and seascapes, ecosystem processes such as nutrient cycling and production, species composition and richness, and diversity of genomes. One could also include earth system processes that affect humans and their well-being, such as the climate system, global hydrologic cycle, or physico-chemical processes that maintain the stratospheric ozone shield. Considerations of the key earth system and ecosystem variables for modeling and monitoring must be an important part of the research

*Research Questions:*

We further propose that future measurements and monitoring programs for sustainability science consider focusing on two key directions:

1. Tracking the stocks and flows involved with critical planetary life support systems – in terms of water, carbon, nitrogen, energy sources, minerals, etc. – that are fundamental to environmental sustainability and human well-being. These measurements need to examine both the current flows (e.g., rates of supply and demand) and stocks (e.g., remaining recoverable resource) over space and time.
2. Tracking the security of food, freshwater, energy, health, biodiversity, etc. at scales of human impact, action and response. These measurements need to address issues at the level of key institutions, households, technologies and innovation, and other social and economic sectors, as exemplified, for example, in National Research Council (2008).

We also propose that measurements be made in two different ways: 1. Long-term, place-based measurements (LTPB), and 2. Large-scale, synoptic measurements across regional and global scales. These may include efforts to:

- a. Build new networks of existing place-based sites for long-term data collection
- b. Develop new meta-analyses of collections of case studies
- c. Develop new syntheses and collections (often mining existing data) of large-scale synoptic measurements, such as:
  1. Census measurements, including those in household samples
  2. National accounts (e.g., GDP, sectoral analysis, Bureau of Economic Analysis, material stocks and flows)
  3. Sensor networks
  4. Remote sensing data on ecosystems, climate, hydrology, etc.
  5. Informational data on genetic resources, biodiversity

We strongly recommend that the sustainability science community organize activities to build *new networks* (of place-based observations, Research Theme C) and *new data syntheses* of large-scale synoptic data, including data mining and integration of already existing large-scale datasets (e.g., Monfreda et al. 2008, Ramankutty et al. 2008). Often aggregate measures (e.g., crop production, food consumption, income) are available only at the national level despite being collected at the local level. Finer scale resolution of the data is often not readily accessible but could be mined and synthesized at relatively low cost, taking advantage of large scale monitoring programs already in place. Synoptic data may be in the form of repeated, aggregated data such as national crop production data, climate observations, satellite data, or in the form of informational databases, such as GenBank for storing global genetic sequence data records for organisms or the Encyclopedia of Life, which stores general information on individual species.



It is essential that *both* modes (place-based and synoptic) of measuring and monitoring be part of the portfolio of sustainability science programs. On the one hand, long-term place-based data have given the community tremendous insight on coupled human-environmental systems (e.g., Matson et al. 1998, Turner et al. 2001, Lauenroth and Burke 2008, M.A. 2005b). It can be argued that place-based studies have generated the most impact on the development of the field. Yet, much of the existing long-term, place-based observation data are spatially “spotty” and some critical socio-ecological systems are completely void of such observation systems. In Research Theme C, we focus on how to create, maintain and use place-based long-term observations to measure progress toward or movement away from sustainability. On the other hand, long-term, large-scale synoptic data are critical in characterizing systematic patterns of human-environment system behavior (e.g., Monfreda et al. 2008, Ramankutty et al. 2008), as well as identifying data gaps and “hot spots” where more in-depth analysis is needed. In the largest river systems in Africa, for example, river gauge measurements have not been made since the 1930s. Biodiversity hot spots are well known and identification of intersections of hot spots for carbon storage, biodiversity, watershed function, etc. can be identified through analysis of large-scale synoptic data.

It may be most useful to envision *a multi-scale monitoring and measuring strategy*, where large-scale synoptic measurements are synthesized and used to inform where more in-depth, place-based studies should be done. This also avoids the trap of assuming that all of the place-based studies are already done in the “right” place. Many place-based studies are performed at locations that are accidents of history – e.g., where the research teams had contacts, field experience, a long history of working, etc. – not necessarily locations that were informed by larger-scale analyses.

Novel in situ and mobile monitoring networks, based on emerging technologies and pervasive monitoring and computation, have the potential to revolutionize decision-making by allowing near real-time integration of data with models. Site-specific and synoptic approaches that capitalize on such technologies are thus likely to augment available information to support a new generation of sustainability science models (see Research Theme A).

In the context of the fundamental work necessary for measuring, monitoring and modeling WEHAB plus sectors, we propose several important research questions. Each of these questions can be addressed within the context of different types of measuring and monitoring systems.

*1. What are the critical parameters for sustainability that need to be measured and monitored?* Determination of critical parameters should be informed by modeling efforts, as explained in Research Theme A. Modeling can help pinpoint which indicators are most informative in determining system behavior. There are large-scale efforts to develop indicators for sustainability that should also be linked to modeling efforts. Measurements of many of these critical parameters are conducted within core disciplines, whereas other may need to be addressed specifically within the framework of sustainability science.

*2. How can methods for data integration and synthesis be developed or enhanced?*

3. *Where are the critical places that data should be monitored for each parameter and at what scale?* Consideration of synoptic large-scale data in concert with modeling should help identify critical sites or networks of sites for monitoring specific parameters. How can multiple scales of observation be integrated to assess sustainability and human well-being? Examination of the efficiency of networks, including optimization of space and time densities of observations, is a priority. In the case of renewable and non-renewable resources, now traded worldwide, the place of origin generally differs from the place of use, and this distinction must be a part of data network design.

4. *What makes measuring and monitoring efforts effective?* Given the critical role of measuring and monitoring in framing and reframing societal debates, influencing decision making and enforcing compliance (Jäger et al. 2001), how can these systems best be designed to achieve effective outcomes?

5. *What makes monitoring resilient and long-lasting?* Issues to consider in this context include resistance to political meddling, economic feasibility, technological feasibility, and transferability across contrasting cultural and political landscapes.

6. *What makes monitoring adaptable to changing needs?*

***C. Creating, Maintaining and Using Long-Term, Place-Based Observations to Measure Progress toward or Movement away from Sustainability.***

As discussed in Research Theme B, WEHAB plus metrics (Box 1) represent the fundamental sectors on which to focus measurement and monitoring to assess progress toward or movement away from sustainability. Gaps in the spatial and temporal coverage of these data, however, impose limits to our ability to quantify and interpret trends. To this end, one of the key efforts for strengthening our current capacities to monitor sustainability is *to initiate, augment and sustain long-term, place-based (LTPB) observations to support sustainability science research.*

Long-term place-based observations, based on the limited cases available, have proven critical for sustainability science. However, they represent the greatest dearth in currently available data. We emphasize place-based measurement and monitoring for three reasons. First, the impacts of sustainable development or lack thereof are often experienced at the local scale. Humans access and use natural resources in particular places (albeit using technologies that are often developed at the global scale, resources that are acquired elsewhere and globally traded, and influenced by institutional arrangements that may also originate at broader scales). Second, the effects of such localized interactions between humans and nature are spatially heterogeneous. Finally, there may be localized hotspots that are disproportionately affecting sustainability and should therefore be measured at the micro scale.

Long-term data are emphasized because of the need to examine and quantify trends over time. We also emphasize both capacity building for sustained data-collection into the future as well as capturing historical data critical in quantifying long-term trends. Given the importance of long-term, place-based observations, a critical question is how such observations may be created, maintained and used. The *overarching goal* of this

research theme is *to create, maintain, and use long-term, place-based observations to measure progress toward or movement away from sustainability*. We emphasize the need to integrate these observations with modeling. Further, we note that modeling and monitoring to understand progress towards sustainability, while dependent on the interlinked WEHAB plus sectors, may have a disproportionately large sensitivity to extreme events (natural, economic, social). Careful consideration in the design of monitoring systems and networks that capture ephemeral data (for example, short-lived data regarding community vulnerability during the aftermath of major hurricanes or power outages) are particularly critical in 1. characterizing and understanding systemic risk and 2. the validation of complex systems models to “surprise” situations involving large-perturbations from the baseline state.

Long-term, place-based (LTPB) observations may come from three types of systems:

1. Networks of sites (examples include the International Forestry Resources and Institutions (IFRI) network, Long-term Ecological Research (LTER) network, US National Phenology Network, Breeding Bird Survey, The Community Collaborative Rain, Hail and Snow Network, etc).
2. Individual sites with over-time observations (examples include the Yaqui valley in Sonora Mexico for which Stanford scholars have over 20 years of observations).
3. Case studies with over-time observations (such as the Maine lobster fisheries and the Valencia Irrigation system)

#### *Research Questions:*

These three types of LTPB monitoring represent an untapped resource for filling some of the crucial gaps related to WEHAB plus data. We propose three clusters of research questions that will help us understand how to these existing efforts may be used to improve our ability to monitor progress toward sustainability.

1. *How may the existing long-term, place-based monitoring systems be combined, expanded, and coordinated to meet critical information needs?* What are these systems measuring and what are their limitations (e.g., spatial coverage, temporal coverage, thoroughness, precision, reliability)? How may these efforts be scaled up to be even more relevant? What are some of the critical areas for external support? What are the technological impediments for measuring, storing, managing, and publishing data?
2. *What makes some monitoring systems more effective than others?* Exploiting the variation in the ways in which networks are organized and their observed performance, comparative research may identify the factors that explain the variation. Potential drivers of monitoring performance include the institutional arrangements that define such things as the degree of decentralization, rewards/punishment for data entry compliance, and the extent to which stakeholders are involved in the planning and actual data collection process. Several possible criteria may be used for assessing the performance/ success of monitoring efforts, including policy relevance, data credibility, usability, availability, accessibility (cyber infrastructure), and the legitimacy of process.

3. *Under what conditions will decision-makers invest in monitoring systems and make use of resulting data?* This is perhaps the most important and understudied area of all. Arguably, without a better understanding of the reasons behind the current underinvestment in relevant and reliable measures of sustainability transitions, we are not in a position to propose better ways of organizing such efforts. Experience shows that one way of stirring the interest of decision makers in investing more in monitoring systems is to involve these decision makers more actively in the early stages of the data collection enterprise (e.g., Oscarson and Calhoun 2007). Increased stakeholder participation can be promoted in a number of ways; for example, through citizen science efforts and the enhanced use of monitoring data for communication, framing of scientific questions, and integration in to policy and decision-making processes (NRC 2009). Research in this area would use comparative case studies and possibly experiments to explore the conditions that are conducive to increased investments in LTPB observation systems.

#### ***D. Transitions: Towards and away from Sustainability.***

Human-environment systems are always in flux, but not all changes are the same. Transitions are large changes that are not easily reversed. Sometimes they seem to occur almost instantaneously as in the phase transitions of water into ice. Many important environmental transitions are relatively rapid, such as toxic algae blooms, fisheries collapses or degradation of rangelands. Some social transitions such as the decline in smoking or, in some cases the adoption of new technologies can also seem rapid. Other important transitions occur over centuries as in the demographic transition of human populations from states of high births and high deaths to low births and low deaths. Systems undergoing transition often seem turbulent, variable and highly uncertain. Now we may be in an uncertain and unpredictable transition of sustainability itself, from desperately unmet human needs and imperiled life support systems to significantly improved human well-being and sustained natural systems. Research to identify, understand, use and manage transitions has become urgent, not only for insights into the coupled and complex adaptive human-environment systems we call our homes, but also for warnings of potentially dangerous shifts in human-environment systems, for opportunities to tip human-environment systems toward beneficial transitions, and to provide measures of progress toward or away from sustainability.

##### *1. Critical Transitions: Early Warnings of “Tipping Points” of Complex Systems Change.*

Incremental, reversible, predictable transitions can be easy to anticipate and manage. But other important transitions involve unexpected shifts that are difficult to reverse. Formerly productive rangelands may become deserts or shrublands, or the expected decline in fertility during the demographic transition may become a downward spiral far below replacement level. These critical transitions emerge from fundamental alterations in system dynamics. Critical transitions in diverse systems – physiology, finance, ecosystems, climate and many others – are announced by early warning signals such as increased autocorrelation, variance and skewness in space and time, or distortion of spatial scaling laws (Scheffer et al. 2009). Early warning signals are known from a wide variety of models, including models of spatially-coupled human-environment systems

(Brock and Carpenter 2006). Empirical evidence of early warnings has been documented in paleoclimate, long-term ecological data and laboratory studies of physical and physiological systems.

*Research Questions:*

Despite these advances, many important questions about early warnings need to be addressed. Three research areas are particularly important:

- a. Detailed studies of relatively realistic models are needed to determine when early warnings can be expected, when false positives or false negatives may occur, and to build understanding of mechanisms of early warnings.
- b. There is enormous need for field studies of early warnings (or lack thereof) in human-environment systems undergoing transitions. When do early warnings occur, when are they heeded and acted upon, and what actions are effective?
- c. Research is needed on the characteristics of policies or management systems that are capable of using early warnings to prevent unwanted transitions or trigger desirable transitions when opportunities arise.

*2. The WEHAB Plus Transitions of the Longue Duree: Powerful Drivers Towards and away from Sustainability.*

In contrast to tipping points, other kinds of non-linear transitions can occur less abruptly, including what we call transitions of 'longue duree'. An exemplar for long transitions has been the demographic transition, as the transition from states of high births and high deaths in human populations have been shifting to low births and low deaths beginning perhaps in France in the early 1800s and still ongoing for much of the world. A great success of analytic social science, it also served to cap the human needs of a sustainability transition as those needs arising from at most a global population of 9-10 billion people. The success of the demographic transition has highlighted the search for other epic transitions, and a number are underway. There is the health transition from ill-health characterized by infectious disease to greater health but marked by chronic disease, a potential energy transition from fossil fuels to nuclear, hydrogen and renewables, a food transition from cereal grains towards high meat consumption, a prospective transition from technologies utilizing scarce resources to those relying on those more abundant, an urban transition from a rural a world to one with 85% living in cities, and a biodiversity transition of extraordinary extinction rates. These transitions mirror the set of long term trends related to a sustainability transition that were highlighted by Kofi Annan at the last world sustainability conference in 2002. These are the WEHAB plus set of water, energy, health, agriculture, non-renewable resources, biodiversity, and urban trends (Box 1) that serve both as critical human needs and as drivers of global change.

*Research Questions:*

The existence of these powerful transitional forces pose three important and interesting research issues:

a. How reliable are the posited transitions in demography, health, energy, non-renewable resources, food and urban dwelling, and how can newly appearing deviations be explained? While many of the well-cited WEHAB plus transitions are still widely accepted, there are newly appearing deviations that are not well understood. For example, the low deaths and low births phase of the demographic transition was thought to lead to an equilibrium population just around replacement. But in the 50 countries where birth rates are now below replacement, population still continues to decline. Another example is the resurgence of infectious disease, such as SARS or the H1N1 pandemic in industrialized countries and the increase in chronic diseases such as diabetes in many developing countries. These trends suggest that both phases of the health transition may co-exist.

b. Some ongoing transitions contribute to sustainability (e.g., declining population growth), some hinder sustainability (e.g., global changes in human diet), and some perhaps do both (e.g., increases in urban dwelling). Are there mechanisms by which societies can accelerate the favorable transitions and slow the ones that make sustainability more difficult?

c. Many transitions seem to have similar patterns over time as “s” shaped or logistic curves of increase or decrease. There is some theory and observations to explain this pattern as the diffusion of innovation, ideas, and the like. Other patterns derive from complex systems dynamics. Is there an underlying common pattern to these transitions that transcends their subject matter and provides insight into what controls their dynamics?

### *3. The Sustainability Transition: Alternative Science-Based Scenarios of the Moving Target of Sustainability.*

Data gaps, random events, nonlinear dynamics of human-environment systems, human volition and the turbulence of the sustainability transition itself make it impossible to predict the future. Nonetheless, scenarios – structured stories about the future, disciplined by data and models – can organize complexity, provide a framework for discussion and debate, evoke new researchable questions, prompt new models, and guide priorities for new measurements and monitoring. Scenarios thereby build understanding of what the future may bring, and inspire ideas about how to manage the controllable, adapt to the uncontrollable, or transform the system to new modes of operation. Over the past 25 years, global scenarios have been used to study potential futures of human development and sustainability, greenhouse gas emissions, and ecosystem services in relation to human well-being (Raskin 2005). There has also been significant progress in the use of scenario analysis to study local or regional futures. This background of experience, combined with the emergence of new modeling, information management, mapping and visualization capabilities makes it an auspicious time to develop a new generation of scenarios to study the sustainability transition.

### *Research Questions:*

The power of sustainability scenarios to inspire alternative trajectories to sustainability, to sketch important interactions, and to be inclusive of decision makers and affected populations suggest three research areas:

- a. Research should examine the existing sets of global scenarios in relation to observed global trajectories since 1990. What global trajectories are consistent with particular scenarios? What trajectories are consistent with no existing scenarios? What are the implications for the sustainability transition to date?
- b. Research is needed to explore processes for scenario construction for local and regional places that integrates local participation and vision with regional and global trends. This initiative would employ a place-based, comparative approach for selected regions of the U.S. Paired locales would be studied in each region, one with scenarios driven by local participation and the other a reference locale, with assessments before and after the scenario exercises.
- c. A new generation of interdisciplinary scenarios for sustainability transitions should be developed, combining qualitative and quantitative approaches, and explicitly addressing interactions across scales from global, to national, to local.

### **Disciplines and Methods Required**

Research Theme A (A New Generation of Models for Study of Sustainable Development) provides a grand challenge to mathematical disciplines and computer science in collaboration with natural, physical and social sciences. Cyber-infrastructure, informed by domain experts from the natural, physical and social sciences, is critical to the multi-scale, long-term monitoring and measuring approaches we have outlined (Research Theme B). Critical also are concerted efforts to collaborate and integrate in-depth field studies and global observations (Research Theme C), again drawing on the physical, natural and social sciences. Long-term place based monitoring efforts will require that knowledge and management of monitoring systems are passed from one generation of researchers to the next. Finally, Research Theme D will draw on all of the other disciplinary and interdisciplinary work in the first three areas and will inform them, in turn, creating a feedback loop.

### **Final Remarks and Cross-Group Questions**

We provide a framework for considering priorities for measuring and monitoring progress toward sustainability. The framework outlined here builds on but transcends contemporary approaches to measuring and monitoring and paves the way for development of a true science of sustainability measuring and monitoring. The research themes we propose tackle issues of scale, uncertainty and the need for linking current and future efforts in time and space; these are critical to managing human-environment systems for sustainability, as outlined by Working Group 4. Complementary to, but distinct from Working Group 2, we strongly recommend developing a new class of models designed specifically for understanding and forecasting trends toward

sustainability that help prioritize data and monitoring needs. We focus on WEHAB plus metrics, recognizing that measuring and monitoring for sustainability requires consideration of both what is to be sustained and what is to be developed. This includes not only monitoring of stocks and flows of resources/indicators associated with WEHAB plus metrics but also researching the linkages between these and human well-being. This latter issue is a critical area for future research developed further by Working Group 1. We propose a multi-scale monitoring approach, prioritized by modeling that integrates global synoptic data collection efforts with long-term, placed based monitoring. Finally, we argue that there is a critical need to understand and forecast the nature of transitions toward or away from sustainability and to develop science-based scenarios for future transitions toward sustainability.



## References

- Annan, K.A. 2002. *Towards sustainable development*. *Environment* (Washington DC). 44(7): 10-15.
- Brock, W.A. and S.R. Carpenter. 2006. Variance as a leading indicator of regime shift in ecosystem services. *Ecology and Society* 11(2): 9. Available from: <http://www.ecologyandsociety.org/vol11/iss2/art9/>.
- Fisher, B., N. Nakicenovic, K. Alfsen, J. Morlot, F. de la Chesnaye, J. Hourcade, K. Jiang, M. Kainuma, E.L. Rovere, A. Matysek, A. Rana, K. Riahi, R. Richels, S. Rose, D.V. Vuuren, R. Warren, B. Metz, O. Davidson, P. Bosch, R. Dave, and L. Meyer. 2007. *Issues Related to Mitigation in the Long-term Context*. Cambridge, United Kingdom and New York: Cambridge University Press.
- Graedel, T.E. and E. van der Voet, eds. 2010. *Linkages of Sustainability*. Cambridge, MA: MIT Press.
- H. John Heinz III Center for Science, Economics, and the Environment. *The State of the Nation's Ecosystems: Measuring the Land, Waters, and Living Resources of the United States*. Washington, DC: Island Press, 2008.
- Kareiva, P. et al. 2005. State of the art in describing future changes in ecosystem services. In M.A. (Millennium Ecosystem Assessment), *Ecosystems and Human Well Being: Scenarios*. Washington, DC: Island Press.
- Jäger, J., N.M. Dickson, A. Fenech, P.M. Haas, E.A. Parson, V. Sokolov, and F. Tóth. Monitoring in the management of global environmental risks. 2001. In: *Learning to Manage Global Environmental Risks*, ed. W.C. Clark, J. Jäger, J.V. Eijndhoven, and N. Dickson. Cambridge, MA: M.I.T. Press.
- Van der Sluijs, J., C. Waterton, P.A. Matson, R.L. Naylor, and I. Ortiz-Monasterio. 1998. Integration of environmental, agronomic, and economic aspects of fertilizer management environment. *Science* 280: 112-115.
- Lauenroth, W.K. and Burke, I.C., eds. 2008. *Ecology of the Shortgrass Steppe: A Long-Term Perspective*. Oxford, UK: Oxford University Press.
- Levin, S.A. 2009. Complex adaptive systems and the challenge of sustainability. *Background paper, Toward a Science of Sustainability Conference*, November 29-December 2, 2009.
- M.A. (Millennium Ecosystem Assessment). 2005a. *Ecosystems and Human Well Being: Conditions and Trends*. Washington, DC: Island Press.
- M.A. (Millennium Ecosystem Assessment). 2005b. *Ecosystems and Human Well Being: Subglobal Assessments*. Washington DC: Island Press.

- Monfreda, C., N. Ramankutty, and J.A. Foley. 2008. Farming the planet: 2. Geographic distribution of crop areas, yields, physiological types and net primary production in the year 2000. *Global Biogeochemical Cycles* 22(GB1022): doi:10.1029/2007/GB002947.
- National Research Council (NRC), Policy Division, Board on Sustainable Development. 1999a. *Our Common Journey: A Transition Toward Sustainability*. Washington, DC: National Academies Press. Available from: [http://www.nap.edu/catalog.php?record\\_id=9690](http://www.nap.edu/catalog.php?record_id=9690).
- National Research Council (NRC), Panel on Integrated Environmental and Economic Accounting. 1999b. *Nature's Numbers: Expanding the National Economic Accounts to Include the Environment*, ed. W.D. Nordhaus and E.C. Kokkelenberg. Washington, DC: National Academies Press. Available from: [http://www.nap.edu/catalog.php?record\\_id=6374](http://www.nap.edu/catalog.php?record_id=6374).
- National Research Council (NRC), Committee to Evaluate Indicators for Monitoring Aquatic and Terrestrial Environments. 2000. *Ecological Indicators for the Nation*, ed. G. Orians. Washington, DC: National Academies Press. Available from: [http://www.nap.edu/catalog.php?record\\_id=9720](http://www.nap.edu/catalog.php?record_id=9720).
- National Research Council (NRC). 2003. *Neon: Addressing the Nation's Environmental Challenges*. Washington, DC: National Academies Press. Available from: [http://www.nap.edu/catalog.php?record\\_id=10807](http://www.nap.edu/catalog.php?record_id=10807).
- Oscarson, D. and A. J. Calhoun. 2007. Developing vernal pool conservation plans at the local level using citizen scientists. *Wetlands* 27: 80-95.
- Ramankutty, N., J.A. Foley, and N.J. Olejniczak. 2008. *Land-Use Change and Global Food Production, in Land Use and Soil Resources*, A.K. Braimoh and P.L.G Vlek eds. New York, NY: Springer Verlag.
- Raskin, P.D. 2005. Global scenarios: Background review for the Millennium Ecosystem Assessment. *Ecosystems* 8: 133-142.
- Scheffer, M., J. Bascompte, W.A. Brock, V. Brovkin, S.R. Carpenter, V. Dakos, H. Held, E.H. Van Nes, M. Rietkerk, and J. Sugihara. 2009. Early warning signals for critical transitions. *Nature* 461: 53-59.
- Tallis, H.M. and P. Kareiva. 2006. Shaping global environmental decisions using social-ecological models. *Trends in Ecology and Evolution* 21: 562-568.
- Turner, B.L., S.C. Villar, D. Foster, J. Geoghegan, E. Keys, P. Klepeis, D. Lawrence, P.M. Mendoza, and S. Manson. 2001. Deforestation in the southern Yucatan peninsular region: an integrative approach. *Forest Ecology and Management* 154: 353-370.

World Commission on Environment and Development (WCED). 1987. *Our Common Future*. Oxford, UK: Oxford University Press.

## Working Group IV: Managing Human-Environment Systems for Sustainability

*F. Stuart Chapin III, Carole L. Crumley, Carla P. Gomes, Thomas E. Graedel, Jacob Levin, Pamela A. Matson, Kira Matus, Samuel Myers, V. Kerry Smith*

### Charge to the Working Group

Explore potential strategies for managing complex adaptive systems with real actors, polycentric problems, and multiple scales of interactions. This requires going beyond identifying the challenges to sustainability management (e.g., population, consumption, environmental externalities, and commons problems).

### Introduction

The planet faces enormous sustainability challenges. With a still-growing human population and rapidly increasing consumption, society must determine how to meet the basic needs of people for food, energy, water, and shelter without degrading the planet's life support infrastructure, its atmosphere and water resources, the climate system, and species and ecosystems on land and in the oceans on which we and future generations will rely (Steffen et al. 2004, MEA 2005, Matson 2009). For example, given current trajectories, society must double food production in the next 40 years to keep pace with demand (Alexandratos 1999), while reducing pollution impacts on aquatic ecosystems and reducing the rates of biodiversity loss associated with land-use change and over-fishing. An improvement in well-being within this ambitious scenario would require improved livelihood opportunities for the poor and a shift in human behavior among others toward goals that seek well-being through a less consumptive lifestyle. This would necessitate radical changes in the management of human-environment systems for sustainability (Chapin et al. 2009).

Sustainability science is use-inspired research (Stokes 1997) that spans and integrates a broad range of science, engineering, and policy disciplines and is directed towards the management of human-environment systems in ways that meet needs for human livelihoods while protecting ecosystem and environmental integrity (Clark and Dickson 2003, Turner et al. 2003). This management requires knowledge based on information that is collected, organized, used to understand and characterize how the human-environment system changes in response to shocks and management activities and is evaluated in ways that allow the manager to “keep score” of changes relative to sustainability goals. Sustainability science also includes research focused on the decision-making process itself, including the behaviors and institutions that underlie decision processes, and the mechanisms by which knowledge and know-how are harnessed to assist in decision-making.

Most human systems that involve private goods and services are managed – delivery of electricity and water, collection of municipal taxes, airline traffic control, international

finances, etc. The record is much less consistent when the resources involved have public and private dimensions.<sup>1</sup> In each of the managed cases, the appropriate decision-makers are identified or appointed, the data necessary to monitor systems behavior are acquired, a target for desirable systems behavior is chosen, and tools and expertise are drawn upon with the intent of moving systems behavior in the direction of the target. At subsequent points in time, using updated information, the process is repeated. The goal in these dynamic systems is to continuously improve in terms of approaching the chosen target or targets.

In principle, the logic for managing human-environment systems with a target of sustainably providing for the needs of human development operates in a similar way. However, the properties of the services and the nature of the delivery systems imply that the information, strategy, characteristics of management systems, and criteria for evaluating performance will be very different. Nonetheless, there are overlaps in many of the aspects of designing management practices. These include addressing questions that parallel those with systems that relate to the delivery of private goods and services:

1. How do we choose what gets managed?
2. What is the information needed for management?
3. What exactly is meant by “managing”?
4. Who does the managing?
5. What management tools are appropriate towards a goal of sustainability?

## **Research Themes**

A. Knowledge systems for sustainable development (i.e., what knowledge frameworks are important for fostering sustainability, and what determines their effectiveness?)

B. Designing management systems for sustainability under uncertainty (i.e., how do we design management systems to achieve sustainability under conditions of inherent uncertainty and paucity of information?)

C. Adaptive governance as a component of management (i.e., how to actively modify the management system to meet unfulfilled goals and in response to changing input and feedback data)

There is some overlap among these topics, and we must be cognizant of issues that cut across all of them, such as system history (human-environment systems have been managed for many millennia – lessons learned even from ancient cultures can be predictive and instructive), opportunities for innovation (incremental and abrupt changes can be brought about through technical or organizational innovations), and the

---

<sup>1</sup> The attributes of a pure public good imply the commodity or service involved is non-exclusionary and non rival.

overarching impact of human behavior (any management structure, regardless of how well designed, necessitates human compliance to be effective).

## **Unpacking the Themes and Articulating a Research Agenda**

### *A. Knowledge Systems for Sustainable Development.*

#### *Introduction*

A knowledge system is a network of linked actors and organizations that perform a number of functions (including research, innovation, development, demonstration, deployment, and adoption) that can link knowledge and know-how with action (Lee 1993). A critical question in the management of human systems is how to design and optimize knowledge systems for sustainable development. We must consider the incentives, financial resources, institutions and human capital that give such systems capacity to do their work and the intention to focus such work in some arenas rather than others. This knowledge includes “formal” knowledge produced by the natural and social sciences, “clinical” knowledge found in engineering and medicine, and “tacit” knowledge of practitioners. “Knowledge systems” are not the result of some master design, but they can be partially understood and manipulated in ways that improve their performance.

#### *Vignette: Climate-Change Effects on Public Health*

We propose that research related to designing or improving knowledge systems can be cast as questions in seven priority areas, described below. We consider the following example to illustrate our thinking: Climate change, in the context of other types of accelerating, anthropogenic environmental change, is expected to impact human health and prosperity in multiple ways including reductions in air quality, changes in the distribution of infectious disease, food and water scarcity, more frequent and intense natural disasters, and large-scale population displacement (Myers and Patz 2009). The capacity of communities to adapt to climate change and reduce their vulnerability will determine, to a large extent, the amount of suffering that results from these disruptions. Such efforts at adaptation will benefit from research into how we can create and optimize managed knowledge systems.

#### *Research Questions*

1. *What are best practices for information/theory-to-practice linkages?* How do we accomplish multi-way knowledge flows between theory and practice (knowledge and decision making) that reflect the multiplicity of sources and uses? What mechanisms allow such flows to take place when the sources mix public and private entities with diverse reward systems and constraints? What is the role of new technologies in improving those flows?

For example, a farmer, observing a new blight on his crops, might use cell phone technology to send a photograph of the blight to the ministry of agriculture which might, in turn, send the photograph to a local or international crop science organization or university. The blight could be diagnosed and entered as data in a surveillance system

while advice for management could be transmitted back to the farmer. Rising frequency of such blights could trigger new research to control its spread.

*2. How and under what conditions does better information lead to better decisions? Is research matched with sustainability needs and ability to manage (is it relevant)? How is information provided and translated? How are options evaluated? What limits or induces the adoption of innovations? How are trade-offs evaluated and managed? Important research may have minimal impact if delivered at the wrong time or in inappropriate ways.*

For example, new approaches to agriculture that increase food security and reduce vulnerability to climate change (altered tillage methods, new seed varieties, or microloans, for example) might be more likely to be adopted if farmers were involved in initial research design or if farm workers had land tenure and were invested in improving soil quality.

*3. How can networks be best designed or modified to mobilize critical knowledge and information and effectively address sustainable development goals? How do power relationships figure into the design process?*

For example, what are the best ways to design regional or international networks of countries to pool risk related to climate-change threats? Could networks be developed to share risk of crop failure or population displacement so that affected countries would be assisted by countries in the network that are less affected? Could informal, community networks be developed in cities to boost social capital and reduce vulnerability to heat waves or epidemics of infectious disease by predefining a community response? How do we encourage co-production/buy-in from all stakeholders?

*4. What processes induce or constrain innovation in the development of new technologies or management approaches for sustainable development? What are the special challenges to innovation for sustainable development that result from creating services that should be a public good?*

For example, how do we encourage innovations that reduce human suffering primarily in poor communities with little capacity to pay? Are there creative approaches to encouraging innovation of more efficient irrigation systems, higher yielding crop varieties, or infectious disease control interventions targeted to poor populations? What is the role of international prizes, or philanthropic payment approaches or other incentives for these types of innovation? Developing a new technology on the bench or even demonstrating it in a pilot study is only the first stage. To have actual impact, social acceptance must be considered to increase the likelihood that technologies developed will actually be used.

*5. How can branch points (critical decision points) be determined and used to manage or shift sustainability trajectories and move onto a more sustainable course in rapidly changing systems (e.g., cities, rural areas, agriculture)?*

For example, after an event like Hurricane Katrina, there is an opportunity to move onto a more sustainable pathway – through restoration of coastal barrier systems, relocation to

higher ground, rebuilding of levees, re-channelization of the river, etc – how do we identify and take advantage of these branch points to shift course (Kates et al. 2006)?

6. *How can deliberative learning be imbedded into management systems? How can monitoring and other feedback mechanisms be incorporated into analysis? How can management interventions be used as experiments that allow learning? When are pilot and demonstration projects feasible? How do we learn from natural events?*

For example, how do we ensure that, when natural “experiments” occur, we learn as much as possible from them and distribute that information to relevant users? How do we mine optimal information from experiences like Hurricane Katrina or the current drought in East Africa? What is the optimal design for intervention trials – for a new approach to infectious disease control, or a new drought-tolerant seed variety, for example, to ensure that the results of such trials are disseminated and adopted?

7. *Do differences among complex systems (or classes of complex systems) influence the optimal decision or management approach and the kinds of decision support systems that are needed?*

For example, the altered distribution of infectious diseases in response to climate change will be slow and incremental, allowing a system of surveillance and response to be developed to address this threat. In contrast, coastal cities with increased vulnerability as a result of more intense storms, sea level rise, and the loss of coastal barriers may experience catastrophic events. In these cases, it will be important to pre-program resources, develop response plans, and alter infrastructure to reduce vulnerability before any “signal” can be detected. The next section addresses in greater detail the strategies for managing complex adaptive systems under uncertainty.

## ***B. Designing Management Systems for Sustainability under Uncertainty.***

### *Introduction*

The management of human-environment systems relevant to sustainable development should be characterized as complex adaptive systems that were described earlier (Levin 1999). The properties of models for these systems emerge from the characterization of a variety of layered interactions. These can be distinguished by the discipline(s) and scale(s) used to identify the layers, by space (geography), by time (system history), and by the boundaries that determine what interacts with what. The knowledge bases underlying these models and the sciences associated with each modeling strategy are uncertain. Of equal importance, the processes themselves have significant unobservable components. As a result, management systems must be designed in ways that accommodate the inherent uncertainty from both our understanding of the systems and from the properties of the systems themselves (Brady et al., 2001; Smith et al. 2006). Recognizing that there are many ways to characterize the design of management strategies, one metaphor that describes the range of possibilities would designate approaches that build in safety margins versus relying on the ability to accurately monitor a system’s outcomes and quickly adjust to identifiable changes so as to maintain system performance. Both strategies acknowledge the uncertainty in human-environment



systems. The first relies on the ability to design robust management practices that can withstand a specified or what might be termed a “design-rated” set of shocks. The second relies on being able to define and measure outcomes that accurately monitor essential system functions and respond to measured changes (that are also assumed to be measured accurately in monitored records). The reality of management reflects both considerations as well as the recognition that system controls are at best indirect.

*Vignette: Hurricane Effects on Flooding*

To illustrate how these features of the problem-space frame researchable questions about the design and evaluation of management strategies, consider a story derived from a real situation (Box 1; De Vries 2008). The story involves a historical perspective on land use, pre-existing infrastructure to help manage flood risks, the management of “normal” flood water in a suburban environment, the linkages in a river system, and rapid-response decisions that must be made to react to a weather related shock (i.e., a hurricane). A severe storm combined with incomplete understanding of the reliability of an earth dam caused municipal leaders in one area to release water from the dam, which caused flooding of distant downstream populations at unprecedented levels – in terms of the length of time for flooded conditions, extent of flooding, and lack of advance warning. What issues would need to be addressed so that management strategies for this human-environment system would have recognized this outcome?

*Research Questions*

1. *How does the decision-making framework change over the course of unexpected events?* The decision-making framework that works efficiently most of the time may be inappropriate to deal with extreme events or surprises – the times when vulnerabilities are often exacerbated.

For example, consider the differences in management choices before any floods and how they affect storm water management in the region and outside the region (the ex ante perspective) and their implications for range of options after the storm has hit but before water releases must be decided (one definition for an ex post perspective).

2. *Develop designs that allow input over different time frames, recognizing importance of information about the definition of the baseline conditions, actions over time, time profile of costs, etc.*

For example, an evaluation of the information and management system for the example will depend on whether the objective is managing land use decisions after the dam is built or monitoring the dam’s integrity or both.

3. *Develop methods for evaluating of tradeoffs associated with the options and their consequences (e.g., tradeoffs between vulnerable and politically powerful stakeholders and between present and future generations, costs of resilience, evaluation of the costs of the flooding to groups differing in income and ability to adjust).*

*4. Develop methods to identify attributes of systems that would allow us to identify those that admit the robust versus the monitored system; does the scale of the outcomes affect the judgment.*

*5. Develop understanding of the properties of instruments to implement management decisions and how are they are affected by what can be monitored.*

### **Box 1: Sustainable Management of River Systems: Impact of Floods**

In the early fall of 1999, Hurricane Floyd came ashore and stalled, causing record amounts of rainfall across the state of North Carolina (De Vries 2008). A few weeks earlier Hurricane Dennis had left the ground saturated, so Floyd created unanticipated demands on a large earthen dam along the Neuse, a river that runs from the state capital of Raleigh to the Atlantic coast. Concerns about its integrity forced managers to release pressure on the dam, resulting in extensive downstream flooding. Along the river's course hog lagoons were breached, farmland was submerged, and the entire populations of several small towns—mostly low-income minority residents—were rendered homeless. While suburban communities near the dam escaped, downstream from the capital thousands of impoverished rural residents experienced catastrophic damage.

Could what seemed like a natural disaster have been avoided? In subsequent weeks, as the story unfolded, the management decision was scrutinized. It became known that the dam's construction was flawed; the actual storage capacity of the dam's reservoir was twenty percent less than had been planned and its managers thought. Even more importantly, dam managers had minimal access to current discharge data for the river and were using out-of-date flood maps; rapid urbanization of farmland around the state capital had exponentially increased runoff across impermeable surface area in the nearly twenty years since the dam was built.

#### **Decision Context and Management**

This event illustrates at least two perspectives for dealing with uncertainty:

##### *Before the Event:*

- What information should managers have had? Minimally, they should have been able to consult up-to-date maps showing developed land and subsequent modifications indicating newly flood-prone areas. The government agency that built the dam erred significantly; the mistake was not discovered and corrected.
- Should the land use restrictions near dam facilities incorporate the collective effect of change in the storm water generating capacity of suburban and urban systems? There is probably no mechanism that collects and analyzes information on water flows in the river under different weather events, which would enable better planning of releases of water from the dam. Research data on water quality does not permit evaluation of the consequences of land use. There is no protocol to test the dam's integrity under different conditions.

##### *After the Event:*

- How is the decision made about who would experience losses? Suburban populations would have higher incomes and be more numerous, but might be more easily to be warned and assisted in evacuation, resulting in reduced loss of life and possessions.
- What would early warning about the storm and the dam have changed for downstream users? Education about their increased vulnerability and the availability of resources for rapid evacuation would have reduced loss.
- What responsibilities do upstream communities have for those downstream?

### *C. Adaptive Governance Systems for Sustainability.*

#### *Introduction*

Governance of complex human-environment systems has proven challenging for institutions and decision-makers. This is in part due to a poor understanding of the system elements and conditions that allow a governance system to adapt its structure and/or strategies from the bottom-up in response to signals to provide desired outcomes (or to protect against negative ones). Well-meaning attempts to set up “adaptive management” schemes often fail, or at best are a process of “muddling through” (Armitage et al. 2007). In order to design, or, as is more likely, reshape existing institutions so that they can effectively manage sustainable development necessitates research into the tools, structures, strategies, and organizations that these problems require. The research also needs to recognize that these institutions are not neat, abstract systems, but must engage with real stakeholders, power structures and inequities, historical legacies, and behavioral responses (Folke et al. 2005, Ostrom 2007, 2009). This engagement occurs across multiple spatial and temporal scales, and with those involved in governance and those impacted by the governance system. The knowledge required to set-up institutions that are capable of dealing with systems management is spread across disciplines, practitioners, and decision-makers. Some of the disciplines that are needed in order to develop the knowledge that is required for effective working of these government structures include political science, public policy, economics, geography, management, along with the engineering, natural and physical sciences that underpin the systems being managed.

To this end, we have identified five key research questions under the theme of “Adaptive Governance Systems for Sustainability” that we believe are compelling, feasible and important components in increasing not only our understanding, but also the ability of institutions and decision-makers to more effectively manage for sustainability.

#### *Vignette: Multi-Resource Adaptive Management*

California has for many years had a water management system to acquire, allocate and distribute water, a scarce resource. It has a similar system for energy, also a scarce resource. A few years ago, Southern California Electric realized that 30% of its energy was being used to pump water, and that if water use could be decreased, so could the use of energy. The company applied to the Public Utilities Commission to allow it to spend customer money on saving water rather than supplying additional power. This request was approved, and SoCal Electric now has employees that survey factories and neighborhoods for excessive water use, hose leaks and the like. If the former system, weakly adaptive only to direct perception of supply and demand, might be termed “Level 1 Adaptive Management,” the current system might be designated “Level 2.” One could imagine incorporating some form of adaptive management of land allocation (agriculture is a big water user) or human choice (personal water use strongly influences demand), but thus far no such “Level 3” system has been implemented.

### *Research Questions*

1. *What is the relationship between characteristics of governance systems and the capacity of those systems to adapt to change? What events and conditions are likely to trigger adaptation at specific temporal or spatial scales? What accounted for their effectiveness (e.g., differences in tradeoffs in cost and benefits)? What characteristics of governance systems facilitate specific types of adaptation (e.g., with respect to sector or institutions or social inequities)?*

For example, in the water/energy vignette, the pressures of declining water supply in southern California triggered changes in the electrical utility, but not in the water management authority or individual water users. The change in governance was triggered by the high-energy cost of water pumping and the prospect of increasing costs, as water management intensified. What properties of the electrical utility enabled it to innovate and adapt more readily than water managers or individuals?

2. *What attributes enable governance systems to manage multiple interacting goals to achieve favorable outcomes? The interacting elements might include resource types, institutional elements, and system features (Graedel and van der Voet, 2010). Management to address multiple interacting goals involves feedbacks that require databases of distinct types of relevant parameters.*

In the water/energy vignette, both power and water were managed more sustainably when the two resources were managed in an integrated fashion. What data were needed to enable this management approach to succeed? What institutional structure or sources of innovation allowed the energy company to operate outside its usual boundaries?

3. *How can various governance structures incentivize, facilitate, and enable behavior that fosters sustainability? For example, how do different incentive structures (public to private) influence behavior of various public, private, and institutional actors? At which scales does each approach work most effectively? What structures are most effective in addressing environmental justice issues?*

In the water/energy vignette, what difference in incentive structure between water and energy managers and various classes of water users caused the energy utility to respond to changes in water availability/energy cost? How can further water savings be incentivized most effectively to equitably meet the needs of multiple stakeholders?

4. *How do cross-scale interactions influence the integration of interacting elements? This includes understanding how to match the scale of problem (actual spatial measurement of affected area) to levels (city, national, international, etc.) and geographical locations of governance; coordinating across these levels and scales; and the possibility of tradeoffs between the value of local experimentation vs. larger-scale coordination. Successful sustainability management at the landscape scale requires attention to interactions with coarse- and fine-scale processes.*

In the water/energy vignette, the affected region and the level of the institutions involved were well matched and were contained within the regulatory structures of a single jurisdiction (California). Could this strategy be scaled up to cover multiple energy

providers across the entire state, or across the regions that supply the area's water? If "Level 3" adaptation (i.e. also considering land use) were attempted, what cross-scale interactions and challenges would be expected?

*5. How do historical legacies and current power structures influence opportunities and barriers to adaptive governance?* A critical sustainability issue is the resistance of many entrenched decision-makers at all levels in both the public and private sphere to facilitate sustainability initiatives. Research on individuals and institutions is needed to improve understanding of the factors that constrain or facilitate actions that facilitate sustainability

For the water/energy vignette, there was a hierarchical power structure, due to the existence of a public utility board that had control over the actions of public (water) and private (energy) providers of resources. In this case, the public utility board agreed to the strategy. Are there other examples of potentially positive actions that have not been taken because of power-struggles between the utility providers and the board? Does the existence of the board make it easier for the energy provider to take action outside of its usual domain by providing legitimacy to its actions via the approval process?

## **Disciplines and Methods Required**

Science in support of decision-making for sustainability often requires interdisciplinary analysis of complex systems and integration of knowledge of various types. Research is needed to develop a suite of new tools and approaches for use in management and decision-making. Research is also needed to address the factors that influence the use of new knowledge in efforts to facilitate sustainability, particularly in regions where technological training and web access is limited or where the most vulnerable groups lack access to information or capacity to shape change. The following list describes some of these new tools and approaches that will assist in decision-making for a transition to sustainability.

*1. Advanced vulnerability assessments.* As decision makers focus on managing challenges of sustainable development, there will be an increasing need to identify those people, places, and environments that are most at risk (Myers 2009). Integrated vulnerability approaches (and vulnerability metrics and measures) address coupled human-environment systems and consider natural characteristics and resources and the human and social characteristics in regard to the impacts, responses, and outcomes of one or more stresses operating on the system (Turner et al. 2003). The tools required for an integrated vulnerability analysis require engagement of many disciplines and of both scientists and practitioners. This will benefit from new communication systems and from the integration of vulnerability analyses with scenario development and planning for action.

*2. Social-ecological models.* Dynamic models of ecosystem processes and services translate what is known about biophysical functions of ecosystems and landscapes or water systems into information about provision of goods and services of importance to society. Such models are critical in allowing, for example, evaluation of the effects of specific policies on the provision of goods and services, or assessment of trade-offs and co-benefits of particular choices of land use for energy systems. Valuation of goods and

services that typically fall outside of the realm of economic analysis remain a significant research challenge (Daily et al. 2000). These models need to be extended to include social outcomes and responses and to incorporate these social feedbacks into the model framework. Because of the unpredictable nature of many human decisions, social-ecological models may be best viewed as tools for developing scenarios of plausible outcomes. Scenarios that differ in costs and benefits can guide planning, as discussed under vulnerability analysis. Formal models that link environment impacts with economic information and analyses and equity issues can give decision makers insights into sustainability objectives under various policy scenarios. Heuristic models and exercises have been developed that engage decision makers, scientists and others in planning exercises and gaming to explore alternative futures.

*3. Virtual laboratories and web portals for social-ecological experiments.* There are practical and ethical constraints on the possibilities for experiments designed to understand the long-term behavior of coupled human-environment systems. Much can be learned from performing computer experiments in a virtual world (Box 2). Advanced computational facilities dedicated to studies of coupled social-ecological systems would greatly advance the opportunities for such studies. These tools can be used to study impacts, tradeoffs, and unintended consequences of decisions in complex systems: e.g., development of scenarios/models, simulation of how to use information and feedbacks in decision making; simulation of evolutionary change; simulation of historical responses; evaluation of pricing, policy decisions as experiments, etc.

This virtual lab would include a collection of problems, benchmarks, datasets, open-source tools, software, annotated dynamic bibliographies, tutorials, blogs and discussions, virtual workshops, panels, publications, etc. Such an infrastructure is essential to the advancement of the science of sustainability allowing researchers to share and replicate results. The key issue is how to create the incentives to build such a virtual lab.

### **Box 2: Tools and Methods for Management of Complex Systems**

Many questions concerning the design of management policies for sustainable development translate into *large-scale constraint reasoning and decision and optimization problems* involving decision variables (such as what portfolio of energy generation and storage a community should use, where to locate an ethanol plant, what fraction of a population should be vaccinated to contain the spread of an infectious disease, whether or not to incorporate a parcel of land in a wildlife reserve for species conservation, whether to build a road or a water well to mitigate poverty, when to open or close a fishing area or a network of fisheries ), a number of resource and socio-economic and political constraints (such as budget limitations and human needs and values), and a number of (often conflicting) goals to be optimized (such as maximizing the social or environmental benefits of the project).

Complexity arises from the fact that we are often dealing with significant uncertainties in the various parameters of our models. This leads to the need of stochastic and more complex decision theoretic models. The complex, dynamic, and intricate nature of sustainability problems is also likely to pose high computational demands, often making approximations more feasible than exact or optimal solutions. For example certain problem relaxations provide extremely good solution bounds on typical problem data. By employing “rounding techniques,” one can obtain performance guarantees for several problems central to computational sustainability.

The research challenges in designing tools for decision and management of complex systems for sustainability consist of a mixture of expanding existing research areas, such as in complex adaptive systems, optimization and constraint reasoning, statistical and machine learning, multi-agent (distributed) systems, as well as new areas of research such as the integration dynamical models with machine and statistical learning and optimization methods in multi agent (distributed) systems. The study of these large scale dynamical decision support tools requires a scientific methodology in which principled experimentation, to explore problem parameter spaces and hidden problem structure, plays as prominent a role as formal analysis.

*4. Integrated social-ecological monitoring and observational systems.* The breadth of the observational requirements for sustainability management and research requires a strategy that provides observations of several different kinds: 1. space-based observations of on-going changes in phenomenon on Earth’s surface and in its atmosphere (Schneider et al., 2005); 2. in situ observations of the biophysical system; and 3. in situ and aggregated observations of socially relevant variables (Ashton, 2008). Many of these observation systems are in place but have been poorly integrated in terms of both the design of observation systems and the sharing and integration of information collected by these systems.

*5. Decision support tools.* There are many sustainability issues that are well defined for specific locations or sectors but that lack the specific decision support tools to make well-informed decisions. In many cases the decision support tools required are well understood but information has not been assembled in ways that allow implementation. The specific information gaps differ among issues (e.g., health, energy, environment) and



locations but are readily identified by planners and decision-makers that address these issues. Tools that are frequently missing are locally appropriate climate and sea-level projections, and health vulnerabilities. Developing locally appropriate decision-support tools for specific issues and places, building on those now common in industry (Brady et al., 2001), constitute a “low-hanging fruit” that would provide tremendous benefit with modest investment of effort. Often the technology and communication systems are well worked out in one location and could be easily modified to be applicable elsewhere.

*6. Data collection and analysis tools.* The quality of the recommendations of our decision support tools depends heavily on the input data. We need to develop new methodologies and models for data collection and inference. For example, to determine the distribution of species or population poverty over time under climate change, one has to develop data and inference models based on highly incomplete data from sparse observations or measurements, changing over time, from multiple sources and highly uncertain. The development of new tools for data collection and monitoring is very important for the management of sustainability systems. For example, the deployment of large sensor networks is becoming a key tool for environmental monitoring. There are several computational challenges concerning the design of such networks. Designing large-scale sensor networks also presents computational challenges (e.g., network architecture, operating system and programming environments, data collection, analysis, synthesis, and inference). For example, when using wireless networks to monitor spatial phenomena, the selection of the best sensor placement in order to maximize the information gain while minimizing communication costs is per se a complex optimization problem requiring new solution techniques. Citizen-science observation networks and crowd-sourcing are new exciting strategies for collecting data and enable the general public to engage in scientific investigation and develop problem-solving skills. Nevertheless, research is required to understand how to effectively use such approaches considering a variety of aspects, ranging from designing mechanisms and incentives for such collective tasks; to handling different levels of expertise of the performers, with corresponding impacts on the quality of the inferences; to social and cultural aspects. Performing inference based on large volumes of data is yet another challenging computational problem for which we need to develop new methods and tools.

## References

- Alexandratos, N. 1999. World food and agriculture: Outlook for the medium and longer term. *Proceedings of the National Academy of Sciences* 96: 5908-5914.
- Armitage, D., F. Berkes, and N. Doubleday, eds. 2007. *Adaptive Co-Management: Collaboration, Learning, and Multi-Level Governance*. Vancouver: University of British Columbia Press.
- Ashton, W. 2008. Understanding the organization of industrial ecosystems: A social network approach. *Journal of Industrial Ecology* 12: 34-51.
- Brady, J.A., E.F. Monk, and B.J. Wagner. 2001. *Concepts in Resource Enterprise Planning*. Boston: Course Technology.
- Chapin, F.S. III, G.P. Kofinas, and C. Folke, eds. 2009. *Principles of Ecosystem Stewardship: Resilience-Based Natural Resource Management in a Changing World*. New York: Springer.
- Clark, W.C. and N.M. Dickson. 2003. Sustainability science: The emerging research program. *Proceedings of the National Academy of Sciences* 100: 8059-8061.
- Daily, G.C., T. Soderqvist, S. Aniyar, K. Arrow, P. Dasgupta, P.R. Ehrlich, C. Folke, A.-M. Jansson, B.-O. Jansson, N. Kautsky, S. Levin, J. Lubchenco, K.-G. Mäler, D. Simpson, D. Starrett, D. Tilman, and B. Walker. 2000. Ecology: The value of nature and the nature of value. *Science* 289: 395-396.
- De Vries, D.H. 2008. *Temporal Vulnerability: Historical Ecologies of Monitoring, Memory, and Meaning in Changing United States Floodplain Ecosystems*. Ph.D. diss., Department of Anthropology, University of North Carolina, Chapel Hill, NC.
- Folke, C., T. Hahn, P. Olsson, and J. Norberg. 2005. Adaptive governance of social-ecological systems. *Annual Review of Environment and Resources* 30: 441-473.
- Graedel, T.E., and E. van der Voet. 2010. *Linkages of Sustainability*. Cambridge, MA: MIT Press.
- Kates, R.W., C.E. Colten, S. Laska, and S. P. Leatherman. 2006. Reconstruction of New Orleans after Hurricane Katrina: A research perspective. *Proceedings of the National Academy of Sciences* 103: 14653-14660.
- Lee, K.N. 1993. *Compass and Gyroscope. Integrating Science and Politics for the Environment*. Washington, DC: Island Press, Washington.
- Levin, S.A. 1999. *Fragile Dominion: Complexity and the Commons*. Reading, MA: Perseus Books.
- Matson, P.A. 2009. The sustainability transition. *Issues in Science and Technology* 25: 39-42.

- MEA (Millennium Ecosystem Assessment). 2005. *Ecosystems and Human Well-being: Synthesis*. Washington, DC: Island Press.
- Myers, S.S. 2009. *Global Environmental Change: The Threat to Human Health*. Washington, DC: Worldwatch Institute/ UN Foundation.
- Myers, S.S. and J. Patz. 2009. Emerging threats to human health from global environmental change. *Annual Review of Environment and Resources* 34: 223-252.
- Ostrom, E. 2007. A diagnostic approach for going beyond panaceas. *Proceedings of the National Academy of Sciences* 104: 15181-15187.
- Ostrom, E. 2009. A general framework for analyzing sustainability of social-ecological systems. *Science* 325: 419-422.
- Schneider, A., K.C. Seto, and D.R. Webster. 2005. Urban growth in Chengdu, Western China: Application of remote sensing to assess planning and policy outcomes. *Environment and Planning B: Planning and Design* 32: 323-345.
- Smith, V.K., J.C. Carbone, J.C. Pope, D.G. Hallstrom, and M.E. Darden. 2006. *Journal of Risk Uncertainty* 33: 37-54.
- Steffen, W.L., A. Sanderson, P.D. Tyson, J. Jäger, P.A. Matson, B. Moore, III, F. Oldfield, K. Richardson, H.-J. Schellnhuber, B. L. Turner, II, and R. J. Wasson. 2004. *Global Change and the Earth System: A Planet under Pressure*. New York: Springer-Verlag.
- Stokes, D.E. 1997. *Pasteur's Quadrant: Basic Science and Technological Innovation*. Washington, DC: Brookings Institution Press.
- Turner, B.L. II, R.E. Kasperson, P.A. Matson, J.J. McCarthy, R.W. Corell, L. Christensen, N. Eckley, J.X. Kasperson, A. Luers, M.L. Martello, C. Polsky, A. Pulsipher, and A. Schiller. 2003. A framework for vulnerability analysis in sustainability science. *Proceedings of the National Academy of Sciences* 100: 8074-8079.
- Weitzman, M. 2009. On modeling and interpreting the economics of catastrophic climate change. *Review of Economics and Statistics* 91: 1-9.

## Appendix A

### **List of Conference Participants with Affiliations Toward a Science of Sustainability Conference November 29, 2009 – December 2, 2009 Airlie Center ~ Warrenton, VA**

#### **Agrawal, Arun**

Professor and Associate Dean for Research  
School of Natural Resources and Environment  
University of Michigan

#### **Anderies, J. Marty**

Associate Professor  
School of Human Evolution and Social Change  
School of Sustainability  
Arizona State University, Tempe, Arizona

#### **Andersson, Krister P.**

Assistant Professor in Environmental Policy  
Political Science Department  
University of Colorado, Boulder

#### **Carpenter, Stephen R.**

Professor of Zoology  
Director, Center for Limnology  
Stephen Alfred Forbes Professor of Zoology  
University of Wisconsin

#### **Cavender-Bares, Jeannine**

Assistant Professor  
Department of Ecology, Evolution, and Behavior  
Resident Fellow, Institute on the Environment  
University of Minnesota, St. Paul

#### **Chan, Kai Ming Adam**

Assistant Professor and Tier 2 Canada Research Chair  
Institute for Resources, Environment, and Sustainability  
College for Interdisciplinary Studies  
University of British Columbia

#### **Chapin III, F. Stuart**

Professor of Ecology  
Department of Biology and Wildlife  
Institute of Arctic Biology  
University of Alaska, Fairbanks

**Clark, William C.**

Harvey Brooks Professor of International Science, Public Policy, and  
Human Development  
Co-director, Sustainability Science Program  
Faculty Chair, ENRP  
Member of the Board, Belfer Center for Science and International Affairs  
John F. Kennedy School of Government  
Harvard University

**Crittenden, John**

Director, Brook Byers Institute for Sustainable Systems  
Hightower Chair and Georgia Research Alliance Eminent Scholar  
Georgia Tech University

**Crumley, Carole L.**

Professor  
Department of Anthropology  
University of North Carolina, Chapel Hill

**Curran, Lisa M.**

Roger and Cynthia Lang Professor in Environment and Anthropology and Senior Fellow  
Department of Anthropology  
Stanford University  
Woods Institute for the Environment

**Dasgupta, Partha**

Frank Ramsey Professor of Economics  
University of Cambridge

**Farmer, J. Doyne**

Professor  
Santa Fe Institute

**Foley, Jonathan**

Director, Institute on the Environment  
Professor, McKnight Presidential Chair  
Department of Ecology, Evolution, and Behavior  
University of Minnesota, St. Paul

**Friedman, Avner**

Distinguished University Professor  
Director, Mathematical Biosciences Institute  
The Ohio State University

**Gomes, Carla P.**

Associate Professor  
Faculty of Computing and Information Science  
Department of Applied Economics and Management  
Department of Computer Science  
Director, Institute for Computational Sustainability  
Cornell University

**Graedel, Thomas E.**

Clifton R. Musser Professor of Industrial Ecology  
Professor of Chemical Engineering  
Professor of Geology and Geophysics  
Director of the Center for Industrial Ecology  
Yale University

**Guckenheimer, John**

Professor  
Mathematics Department  
Cornell University

**Jäger, Jill**

Senior Researcher  
Sustainable Europe Research Institute (SERI)  
Vienna, Austria

**Jain, Shaleen**

Assistant Professor of Civil and Environmental Engineering  
Cooperating Assistant Professor, Climate Change Institute  
University of Maine, Orono

**Kates, Robert W.**

University Professor (Emeritus)  
Brown University  
Presidential Professor of Sustainability Science  
University of Maine, Orono

**Kinzig, Ann P.**

Associate Professor  
School of Life Sciences and School of Sustainability  
Arizona State University

**Levin, Jacob**

Assistant Vice Chancellor for Research  
University of California, Irvine

**Levin, Simon A.**

George M. Moffett Professor of Biology  
Department of Ecology and Evolutionary Biology  
Director, Center for BioComplexity  
Affiliated Faculty, Program in Applied and Computation Mathematics  
Princeton University

**Liu, Jianguo**

Rachel Carson Chair in Sustainability  
University Distinguished Professor  
Center for Systems Integration and Sustainability  
Michigan State University

**Matson, Pamela A.**

Chester Naramore Dean  
School of Earth Sciences  
Richard and Rhonda Goldman Professor of Environmental Studies  
Stanford University

**Matus, Kira**

Senior Policy Analyst  
Center for Green Chemistry and Engineering  
Yale University

**Morgan, Granger**

Lord Professor in Engineering  
Professor and Department Head, Engineering and Public Policy  
Professor, Electrical and Computer Engineering and Heinz College  
Carnegie Mellon University

**Myers, Samuel, MD, MPH**

Instructor of Medicine  
Center for the Environment  
Harvard Medical School

**Philander, Samuel George**

Knox Taylor Professor of Geological Sciences  
Department of Geological Sciences  
Princeton University

**Polasky, Stephen**

Fesler-Lampert Professor of Ecological/Environmental Economics  
Department of Applied Economics  
Professor, Department of Ecology and Evolutionary Biology  
University of Minnesota

**Ramanathan, Veerabhadran**

Victor C. Alderson Professor of Applied Ocean Sciences  
Professor of Atmospheric Sciences  
Director, Center for Atmospheric Sciences  
Scripps Institution of Oceanography  
University of California, San Diego

**Sims, Katharine R.E.**

Assistant Professor  
Department of Economics  
Department of Environmental Studies  
Amherst College

**Smith, V. Kerry**

Professor  
Department of Economics  
W.P. Carey School of Business  
Affiliated Faculty, School of Sustainability, School of Geographical Sciences  
Arizona State University, Tempe

**Trancik, Jessika**

Assistant Professor  
Engineering Systems Division  
Massachusetts Institute of Technology  
Omidyar Fellow  
Santa Fe Institute

**Turner II, B.L.**

Gilbert F. White Professor of Environment and Society  
School of Geographical Science and Urban Planning  
Affiliate Faculty, School of Sustainability  
Arizona State University

**Turner, Monica G.**

Eugene P. Odum Professor of Ecology  
Department of Zoology  
University of Wisconsin, Madison

**Zeeman, Mary Lou**

R. Wells Johnson Professor of Mathematics  
Department of Mathematics  
Bowdoin College



## Appendix B

### Agenda Toward a Science of Sustainability Conference November 29, 2009 – December 2, 2009 Airlie Center ~ Warrenton, VA

<b>Sunday</b>	Arrivals		
	7:00 PM	Dinner	
	8:30 PM	Welcome mixer	
<b>Monday</b>	7:30	Breakfast	
	8:45	Opening session: Levin and Clark: Charge to group	
	9:00	Peter March: Perspective from NSF	
	9:15	Shere Abbott: Perspective from USG/OSTP	
	9:30	Discussion	
	9:45	Break into 4 working groups, discussion of objectives within groups	
	11:00	Coffee break	
	11:15	Resumption of working groups	
	12:15	Lunch	
	14:00	Groups A, B, C meet (Group D splits)	
	15:15	Coffee break	
	15:30	Groups A, B, D meet (C splits)	
	16:45	Plenary	
	18:15	Dinner	
	20:00	Special discussion session Earth System Science Partnership, Stephen R. Carpenter Planetary stewardship, F. Stuart Chapin III	
	<b>Tuesday</b>	7:30	Breakfast
		8:45	Levin and Clark: Charge to group
9:00		General discussion	
9:30		Groups A, C, D meet (B splits)	
10:45		Coffee break	
11:00		Groups B, C, D meet (Group A splits)	
12:15		Lunch	
14:00		All 4 working groups meet	
15:15		Coffee break	
15:30		Plenary: Updated reports from working groups	
16:45		Resumption of group meetings	

18:15 Dinner  
20:00 Rapporteurs and helpers for each group draft conclusions and presentations

**Wednesday**

7:30 Breakfast  
8:45 All groups meet to finalize conclusions, two groups in main room  
  
10:15 Coffee break  
10:45 Final plenary session; discussion of recommendations, publication, follow-ups  
12:15

## Appendix C

### Background Papers for the Conference

*List of Papers (Page 79)*

*Overview (Pages 80-100)*

1. Sustainable Development and Sustainability Science

*William C. Clark (Pages 80-100)*

*Human Well-Being and the Natural Environment (Pages 101-117)*

2. Human Well Being and the Natural Environment:

A Focus on Ecosystem Services (*Pages 101-108*)

*Ann P. Kinzig*

3. Sustainable Development and Comprehensive Wealth (*Pages 109-117*)

*Partha Dasgupta*

*Human-Environmental Systems as Complex Adaptive Systems (Pages 118-128)*

4. A Landscape Perspective on Sustainability Science (*Pages 118-122*)

*Monica G. Turner*

5. Complex Adaptive Systems and the Challenge of Sustainability (*Pages 123-128*)

*Simon A. Levin*

*Measuring and Monitoring Progress Toward Sustainability (Pages 129-141)*

6. Measuring and Monitoring Progress Toward Sustainability (*Pages 129-133*)

*Stephen R. Carpenter*

7. Measuring and Monitoring Toward Sustainability (*Pages 134-141*)

*Veerabhadran Ramanathan*

*Managing Human-Environmental Systems for Sustainability (Pages 142-156)*

8. Managing Human-Environmental Systems for Sustainability (*Pages 142-146*)

*Arun Agrawal*

9. Managing Human-Environmental Systems for Sustainability:

The Ultimate Systems Problem (*Pages 147-156*)

*Thomas E. Graedel*

# Sustainable Development and Sustainability Science

Adapted by

Bill Clark

From a monograph on *Sustainability Science* in preparation by  
John Bongaarts, Steve Carpenter, Partha Dasgupta, Bob Kates, Elinor Ostrom, Pam Matson,  
John Schellnhuber and Bill Turner

Plus the proposal to NSF for this Workshop, co-authored with  
Simon Levin

*This paper is based on the proposal to NSF for this workshop, plus a draft of the first chapter of a monograph on sustainability science now being prepared by the team listed above. Although versions of the monograph chapter have been contributed to and commented on by all of the authors listed above, this condensed version has not been reviewed by anyone but me. Problems of content or taste are therefore entirely my fault. I, and my colleagues, look forward to broadening and deepening our perspectives through discussions at this workshop. Comments and suggestions for change will be most gratefully received.* Bill Clark ([william\\_clark@harvard.edu](mailto:william_clark@harvard.edu))

## Contents

1 Sustainable Development.....	2
2 Contemporary Challenges of a Sustainability Transition .....	4
3 Science, technology and sustainability .....	5
4 Sustainability Science .....	6
4.1 Problem-driven focus on human-environment systems:.....	7
4.2 Integrative approach to understanding complex human-environment interactions:.....	7
4.3 Attention to the cross-scale dimensions of human-environment interactions .....	8
4.4 Boundary-spanning work at the interface of research and practice.....	9
5 Toward a Workshop Agenda .....	10
5.1 Human well being and the natural environment .....	11
5.2 Human-environment systems (HES) as complex adaptive systems .....	11
5.3 Managing HES for sustainability .....	12
5.4 Measuring and monitoring progress toward sustainability .....	12
Figures.....	13

This paper provides an overview of the context for the workshop. It begins with a discussion of the origins and present status of the idea of sustainable development. Next, we illustrate the range of contemporary challenges facing those who would promote a transition toward sustainability. We then trace emerging efforts to better harness science and technology to advance the sustainability agenda. Finally, we provide one characterization of the emerging field of sustainability science, and pose the organizing questions for this workshop.

# 1 Sustainable Development

The challenge of sustainable development has been broadly understood since humans began to spare gravid game, fallow their fields, and dump their wastes downstream. But it received its modern formulation from the World Commission on Environment and Development (WCED, also known as the Brundtland Commission), which wrote in 1987:

“Environment is where we live; and development is what we all do in attempting to improve our lot within that abode. The two are inseparable.... Humanity has the ability to make development sustainable: to ensure that it meets the needs of the present without compromising the ability of future generations to meet their own needs.”<sup>1</sup>

Through the 1990s, an increasing number of localities, corporations and nations began to bring the sustainability thinking articulated by the Brundtland Commission into their planning and operations. And by the beginning of the 21<sup>st</sup> century, sustainable development had taken its place at the high table of global affairs. UN Secretary General Kofi Annan was reflecting a broad consensus when he argued in his Millennium Report to the General Assembly that the three great interlinked challenges facing the international community in the decades ahead were helping the world’s peoples to secure “freedom from want, freedom from fear and the freedom of future generations to sustain their lives on this planet.”

Perhaps not surprisingly for an idea that has resonated so widely, “sustainable development” – like the comparably big ideas of “justice” and “freedom” -- has come to mean different things to different people. There is, however, some structure to this variety. As pointed out by the US National Research Council (NRC), at least four common questions about the concept are explicitly or implicitly addressed by almost every definition: *What is to be sustained? What is to be developed? What is the relation between what is to be sustained and what is to be developed? Over what scales in space and time are those relationships meant to hold?* Figure 1.1 reproduces the NRC’s efforts to classify the way different people have answered these questions in their framing of the debate over sustainability.<sup>2</sup>

*[Figure 1 (NRC classification of framings) near here]*

A moment’s inspection of the figure suggests why arguments that are ostensibly about what impedes sustainable development or how to achieve it often turn out to be about much more fundamental differences in values and goals. The raw materials for more subtle confusions over ends and means are apparent as well. An example within the “What’s to be sustained?” question, for example, is whether healthy ecosystems are viewed as an end in themselves, or merely as a means to secure key ecosystem services. With regard to “What is to be developed?” the same difficulties arise over the position of education relative to child survival. To clarify such confusions a number of formal definitions and frameworks of sustainability have been proposed. None – including the one we present here -- are entirely successful in capturing in operational form the richness and intensity of the sustainability debate. But if a general theory capturing all of the details of sustainability is neither feasible nor, perhaps, desirable, greater clarity of intention and perspective on the part of scholars working in the field is both. It is

therefore worthwhile to locate the treatment of sustainable development presented here relative to the range of perspectives suggested in Figure 1.

For present purposes, we propose a perspective on sustainability that is broad but unabashedly anthropocentric. Despite the awe in which we hold nature and the value we place on its conservation, ours is ultimately a project that seeks to understand what is, can be, and ought to be the human use of the earth. We pursue this goal, however, in the conviction that what is possible and desirable for people can only be understood through an appreciation of the *interactions* between social and environmental systems. Our answer to “What is to be developed?” thus incorporates dimensions of the economy, of peoples’ well-being, and of the social institutions and other forms of capital assets on which development depends. Our answer to “What is to be sustained?” embraces a somewhat narrower set of the possibilities suggested in Figure 1, focusing on resources and the “life support systems” provided by the interlinked geophysical, chemical, and ecological processes on which humanity depends for its well-being.

Our scales of interest are also broad. In the time domain, while recognizing that important interactions between social and environmental systems occur at all scales, we have found it most helpful to *focus* on what might be called “grandchildren” time: periods of more than years but less than centuries. Because ideas and policies, and the structure of social organizations and technologies of the present cast a significant shadow on the future, we adopt a dynamic view, emphasizing not some distant goal of achieving sustainable development, but rather on contemporary progress (or lack thereof) along a transition *toward* sustainability.

With regard to spatial scale, our appreciation of the degree to which human action has already transformed the earth on planetary scale leads us to address the sustainability question from a global perspective. That said, however, our work has also led us to appreciate that the nature of interactions between social and environmental systems can often be best understood, and effective *options* for managing those interactions often must be designed, in the *context* of specific places. How different those contexts may be for people working in or on different parts of the world is suggested in Figure 2. The stark contrast it portrays of sustainability challenges in the rich and poor parts of the world was originally drawn by one of our southern colleagues during a hot exchange at an international workshop that helped to launch the sustainability science effort we report on here.

[Figure 2 (Friiberg triangles) near here]

To address the importance of context, we thus emphasize in our approach the need to *identify* rather than assume the relevant scales – generally larger than the purely “local now,” but smaller than the “global forever” – at which we can make most sense of humanity’s continuing struggle to shape a transition toward sustainability.

In summary, we approach sustainability science from a normative commitment to “sustainable development,” which we – following the NRC -- see as promoting improvements in human well-being while conserving the earth’s life support systems. As a practical matter, while recognizing the planetary, millennial character of the sustainability challenge, we focus on

integrated regional efforts embedded in a globalizing world to promote a transition toward sustainability on decade to century (grandchildren) time scales.

## 2 Contemporary Challenges of a Sustainability Transition

The struggle to promote a sustainability transition has clearly achieved significant progress over the twenty plus years since the Brundtland Commission issued its report. Nonetheless, the challenges remaining today – and those looming on the horizon -- appear more daunting and urgent than ever. Consider the following examples:

**Persistent poverty and hunger:** Human ingenuity over the last 30 years has led to significant increases in the productivity of natural systems used to support agriculture, helping to fend off hunger and raise living standards for hundreds of millions of people. But for some regions -- especially in sub-Saharan Africa – humanity has not yet learned how to exploit more than a fraction nature’s potential to provide people with food and fiber. Moreover, almost everywhere the rate of increase in agricultural productivity is now declining and the environmental damages associated with agricultural production are accelerating. The World Bank’s 2007 World Development Report bluntly concludes that the Millennium Development Goals for alleviating hunger and poverty cannot be met unless these trends are reversed.<sup>3</sup>

**Rising costs of economic growth at the national level:** China’s economy has been the wonder of the modern world, growing at 9-10% annually for much of the last decade. Resulting improvements in human well-being have been substantial though uneven across regions of the country. This rapid growth, however, has brought about significant environmental degradation, now estimated to cost the country in lost health, agricultural productivity and materials damage the equivalent of at least half of its nominal GNP growth.<sup>4</sup> These losses, also disproportionately born across the nation, have been described by China’s Environment Minister as “a blasting fuse for social instability,” and resulted in a stated commitment by President Hu Jintao “to put economic growth on a more socially and environmentally sustainable path.”<sup>5</sup>

**Accelerating degradation of the earth’s life support systems:** Evidence is rapidly growing that the unprecedented demands made by the earth’s human population over the last half century are stressing the earth’s life support systems to – or beyond -- the breaking point. The Millennium Ecosystem Assessment, released in 2005, reported that more than 60% of the essential ecosystem services it surveyed worldwide were significantly degraded, including damage to the earth’s fisheries, freshwater supplies, and biodiversity. And the most recent report of the Intergovernmental Panel on Climate Change, published in 2007, is already in need of revision to account for the faster than expected growth of emissions, floods, fires, and ice melt being reported in scientific conferences and the world news.

Other examples of today’s sustainability challenges could be cited from around the world, together illustrating a sometimes bewildering array of problem definitions, professional approaches, and conceptual frameworks. What they would also show, however, is an increasingly world-wide recognition of the urgent need for action to make development both more effective and more sustainable. Many groups are seeking to step up to this challenge, including leaders from civil society, corporations, governments and, increasingly, the scholarly

community. Our focus here is on the last of these groups, and on what science can bring to society's collective effort to foster a transition toward sustainability.

### 3 Science, technology and sustainability

Scientific research on problems relevant to sustainable development is not new. Basic research on the (usually one-directional) impacts of humans on the environment, or of the influence of environments on society is of ancient lineage. A tradition of scholarship on the *interactions* between people and their environments dates back at least to the 19<sup>th</sup> century work of Alexander von Humboldt and George Perkins Marsh. Historians and geographers of various persuasions have systematically pursued questions of such interactions for almost a century, while resource economics has a relevant tradition of research going back for at least 50 years. More recently, explicitly interdisciplinary studies of human-environment systems have come to occupy increasingly prominent places in national and international research agendas.<sup>6</sup> (The focus of this body of research is also referred “socio-ecological” systems. We have, somewhat arbitrarily, adopted what we see as the broader “human-environment” formulation here, while drawing extensively from the “socio-ecological” tradition as well).

Applied research on human-environment interactions has an even richer legacy. Indeed, some of the earliest writings on what is now seen as the challenge of sustainable development came from scholars concerned with the productive management of natural resources. And much of the environmental movement of the 1960s was based upon concerned scientists' delineation of the impacts of pollution resulting from economic growth. By the late 1970s, however, the inadequacies of this competitive framing were becoming increasingly clear. A more contemporary-sounding scientists' framing of the sustainability debate was articulated by the International Union for the Conservation of Nature, which argued in its 1980 *World Conservation Strategy* that goals of protecting the Earth's lands and wildlife could not be realized except through strategies that also addressed the improvement of human well-being in conservation areas. This is essentially the view that was reformulated to encompass social-environment interactions more broadly in the report of the Brundtland Commission quoted above.

Calls for integrating basic and applied research perspectives to strengthen the contribution of S&T programs to sustainable development built slowly during the 1990s following the UN Conference on Environment and Development (UNCED) in Rio de Janeiro. Many of the earliest and most thoughtful contributions to this discourse came from the developing world through the work of individual scholars and of institutions such as the Third World Network of Scientific Organizations (TWNISO), the Commission on Science and Technology for Sustainable Development in the South (COMSATS), the Society for Research and Initiatives for Sustainable Technologies and Institutions (SRISTI), and the South Center.<sup>7</sup> A further regional perspective was provided by the African Academy's *Millennial Perspective on Science, Technology and Development*.<sup>8</sup> European thinking of the late 1990s was exemplified in Schellnhuber and Wenzel's *Earth Systems Analysis: Integrating Science for Sustainability*, the European Union's *Fifth Framework Programme*, and a special issue on “Sustainability Science” published by the *International Journal of Sustainable Development*.<sup>9</sup> A number of national academies of science or other advisory bodies – including those of Brazil, Germany, Japan, the United Kingdom, and



the United States also addressed the links between sustainability and global change.<sup>10</sup> Many of these perspectives were brought together in UNESCO's *World Conference on Science for the 21st Century*, held in Budapest in 1999.<sup>11</sup>

With the turn of the Millennium, discussions on science, technology and sustainability intensified significantly. From the scientific community itself, national and international stock-taking on the first decade of research on global environmental change research provided opportunities for rethinking the relationships among science, technology and sustainability.<sup>12</sup> In the policy arena, international environmental assessments were increasingly called upon to address sustainability issues.<sup>13</sup> And on the political side, the World Summit on Sustainable Development (WSSD), held in Johannesburg in 2002, created the impetus for an extensive set of workshops, consultations and declarations focused on the challenge of harnessing the potential of science and technology to social goals for sustainable development.<sup>14</sup> International leadership for these ventures was provided by many groups, including the International Council for Science (ICSU), the Academy of Sciences of the Developing World (TWAS), the European Sustainability Science Group (ESSG); the Earth Systems Science Partnership (ESSP) of the international global change research programs, and an ad-hoc, international group of scholars brought together as the Initiative on Science and Technology for Sustainability (ISTS).<sup>15</sup> A cumulative result of all this activity has been the emergence of a field increasingly referred to as "sustainability science."

## 4 Sustainability Science

Sustainability science has emerged over the last decade at the center of a diverse set of research and innovation activities relevant to society's efforts to support a transition toward sustainability. Today, it has developed elements of a shared conceptual framework, sketched a core research agenda and set of associated methods, and is producing a steadily growing flow of results. The present workshop is aimed to pull together some of this disparate foundational material, with a view toward stimulating research collaboration and support for the growing number of programs committed to teaching and doing sustainability science.

As noted earlier, our own ultimate question for sustainability science is how to improve human well-being in ways that account for the ultimate dependence of that well-being on the natural environment. By human well-being we mean not only for the current generation, but also for future generations; not only for some places at the expense of others, but for all, and humanity as a whole. In the course of addressing this ultimate question, there immediately arise a number of subsidiary challenges for sustainability science: How should the well-beings of different persons (whether or not they are contemporaries) be aggregated? How do the "assets" – human, manufactured, natural, and intellectual – inherited by each generation from its past contribute to human well-being? How substitutable, within what limits, are these assets for meeting human needs and preferences? What is the role of scientific and technological progress in improving human well-being? What role do institutions play in enabling people to use the services that various assets provide for maintaining and improving their lives? Such questions have motivated our individual efforts in the field of sustainability science, and our joint commitment to write this monograph on what we see as the present state and future prospects of efforts to answer them.

Before proceeding to the particulars of our argument, however, it will be useful to sketch four broad characteristics of sustainability science that, taken together, help to distinguish *how* it addresses its questions. These are discussed below in terms of what we see to be the field's i) problem-driven focus on human-environment systems; ii) integrative approach to understanding complex human-environment interactions; iii) special attention to the cross-scale dimensions of those interactions and iv) its boundary-spanning work at the interface of research and practice.

#### 4.1 Problem-driven focus on human-environment systems:

Like “agricultural science” and “health science” before it, sustainability science is a field defined by the problems it addresses rather than the disciplines or methods it employs. For us, those problems are defined as the challenges of promoting a transition toward sustainability -- improving human well-being while conserving the earth's life support systems over appropriate time and space scales. Sustainability science then draws from -- and seeks to advance -- those aspects of our understanding of human systems, environmental systems and their interactions that are useful for helping people achieve sustainability goals. A first approximation of the domain of sustainability science can be seen in terms of the area of overlap in Figure 3.

*[Figure 3 (Venn diagram of H-E systems and SD goals) near here]*

The *broad context* of sustainability science can thus be seen as shaped by the changing social goals of sustainable development, and changing human systems and environmental systems within which efforts to achieve those goals are necessarily carried out (ie. the totality of Figure 3). The *core* of sustainability science, as we see it, lies in seeking to understand how society's efforts to promote a transition toward sustainability are constrained or promoted by the interactions between human and environment systems (the heavily shaded portion of Figure 3). Beyond this core, sustainability science also includes the investigation of social systems alone, or environmental systems alone, to the extent that such investigation is motivated by efforts to address the challenges of sustainability (the lightly shaded portions of Figure 3).

#### 4.2 Integrative approach to understanding complex human-environment interactions:

A second and related characteristic defining our view of sustainability science is its integrative approach to understanding complex human-environment interactions. The nature and extent of this commitment can be thought of in terms of a full version of the matrix partially sketched in Figure 4.<sup>16</sup>

*[Figure 4 (the matrix) near here]*

Here, the rows of the matrix represent dimensions of human well-being – the “what is to be developed” of Figure 1. The columns, in turn, reflect some of the planet's key life-support systems -- the “what is to be sustained” of Figure 1. The specific examples listed here are drawn from those most prominently noted as goals or targets in recent international declarations.

A great deal of research and innovation relevant to sustainability focuses on problems at the level of particular “cells” of Figure 4. Examples include studies of how efforts to meet energy needs impact the climate system or, more rarely, how the climate system impacts people’s abilities to meet their energy needs or, rarer still, the interactions between human efforts to meet their energy needs and the climate systems. More integrative work, often performed in the context of international assessments, can be seen as “summing” across individual rows or columns of the matrix. Thus, the International Assessment of Agricultural Science and Technology for Development<sup>17</sup> is essentially a “horizontal” study, evaluating the impact of different options for meeting food needs on, among other things, the environment. In contrast, the Intergovernmental Panel on Climate Change is essentially a “vertical” study, evaluating how efforts to achieve multiple human needs jointly affect climate, and how climate change will impact human activities. To the extent that such integrative assessments are driven by sustainability goals and examine the two way interaction of (some) efforts to meet human needs with (some) aspects of the earth’s life support systems, they may be seen as potential contributions to sustainability science.

A more quintessentially sustainability science problem is that posed by the prospect of significant development of biofuels over the next decades. Bio-fuel developments could have immediate implications for society’s abilities to meet human needs for at least energy and food and water, while at the same time having consequences for life support systems involving climate, biodiversity conservation, the hydrologic cycle and so on. Studies meant to evaluate the prospects of promoting a sustainability transition through development and deployment of bio-fuel technologies therefore need to be conducted in an integrative manner that addresses the complex interactions occurring across multiple cells and rows of the Figure 4 matrix. In short, such studies need sustainability science.

### **4.3 Attention to the cross-scale dimensions of human-environment interactions**

As noted earlier, questions of spatial and temporal scale pose an additional dimension of complexity that needs to be addressed rather than sidestepped if science is to support sustainability. Human and environmental systems interact across a variety of scales. As shown in Figure 5, these are generally mismatched.<sup>18</sup>

*[Figure 5, scales of interaction, near here; NEEDS UPDATING]*

The mismatch means, for example, that given a spatial scale, social processes (be they economic or governmental) are likely to be too sluggish to deal easily with the rapid changes normally associated with atmosphere, but too rapid and impatient to recognize and manage many slow but important ecological changes (eg. soil depletion). Similarly, at a given temporal scale, social processes (eg. national governance) generally have too small a span of control to manage many atmospheric phenomena, but are simultaneously too coarse to deal easily with important ecological heterogeneities. Finally, human and environmental systems, whether coupled or relatively independent, exhibit the potential for both amplifying and damping small-scale fluctuations and innovations.

Much of the challenge of promoting sustainability ends up being about dealing with the cross-scale phenomena that characterize interactive social and environmental systems. Much scholarship tends to marginalize or assume away the complexity of cross-scale, interactive human-environment systems. Sustainability science strives to embrace and understand the consequences of such complexity, and to identify the scales at which it becomes most comprehensible and manageable.

#### 4.4 Boundary-spanning work at the interface of research and practice.

A fourth defining characteristic of sustainability science, as we see it, is its uneasy position at the interface of detached scholarship and engaged practice. In part, this is due to the simple observation that successful instances of promoting a sustainability transition – whether through green revolution agriculture or green chemistry -- have generally needed to draw upon both generalizable findings derived from classical scientific research *and* context-dependent knowledge derived from practice and experience. In addition, however, the need for integrating knowledge and action arises from our incomplete understanding of the dynamics of coupled human-environmental systems. Very often, the only way that we can assess the validity of a new insight or the potential of a new innovation is to put it into practice as part of a real world management regime. Policy thus becomes a primary mode of experimentation, and learning-by-doing an inescapable component of strategies for linking knowledge with action to promote a sustainability transition. Finally, there are the more mundane issues associated with the previously noted need to integrate across social and natural science disciplines in order to provide useful knowledge for managing sustainability. For all these reasons, deep epistemological questions regarding the generalizability and reliability of knowledge produced through such hybrid mechanisms thus become central concerns of sustainability science, as do practical questions of adaptive management.<sup>19</sup> More broadly, scientists seeking to promote a sustainability transition need to develop an ability to span not only disciplines, but the barriers separating scholars from practitioners.

Sustainability science is thus best conceptualized as neither “basic” nor “applied” research.<sup>20</sup> Rather, it is an enterprise centered on the “use-inspired basic research” that the late Donald Stokes characterized as “Pasteur’s Quadrant” of the modern scientific enterprise. It is worth reviewing Stokes’ argument briefly for the insights it provides into how good sustainability science is likely to be conducted, and what resistance it is likely to encounter from more conventional approaches. Stokes argued that the conventional dichotomy of “basic vs. applied” research was neither historically justified nor empirically useful in making sense of science as it is actually practiced. In its place, he presented substantial historical evidence that the two-dimensional classification shown in Figure 6a was both more realistic and more helpful.

*[Figure 6a,b (Stokes static and dynamic) near here]*

In this “Quadrant Model of Scientific Research”, investigators are seen as making at least two choices rather than one in their choice of topics to pursue: first, whether the objective of the study is to produce useful knowledge or not; second, whether the objective is to produce generalizable knowledge or not. One diagonal of the resulting matrix defines the classic

spectrum of basic research (“Bohr’s Quadrant) vs. applied research (“Edison’s Quadrant”). But there is another cell in the matrix that Stokes argues has been the source of much of the most productive science in history: the use-inspired basic research typified by Pasteur’s simultaneous discovery of the practically important method for what we now call “Pasteurization” of milk at the same time he was inventing the germ theory of disease. As Stokes concludes, “the mature Pasteur never did a study that was not applied, as he laid out a whole new branch of science.”<sup>21</sup> Similarly, sustainability science finds itself probing fundamental questions of complex adaptive systems, even as it seeks to design specific, context embedded solutions to problems of mixed-use forest management.

The implications of Stokes’ insights for efforts to link knowledge with action in support of sustainability are profound. These implications can best be seen in a second diagram suggested by Stokes that traces the dynamic relationships among basic research, applied research, and the use-inspired basic research of Pasteur’s Quadrant (see Figure 6b). In this view, basic research efforts to improve understanding generally evolve independently of applied research efforts to improve policy and technology. At key moments, however, efforts at “use-inspired basic research” provide a bridge between these two separate streams of work, promoting cross-fertilization and mutual enrichment. As suggested in Figure 6b, a defining characteristic of sustainability science is its work in this crucial bridging role, serving the quest for advancing both useful knowledge and informed action by creating a bridge between the two.

## 5 Toward a Workshop Agenda<sup>22</sup>

To advance the science of sustainability – to understand the complex and dynamic interconnections among human and environmental systems, and to mobilize that knowledge to inform effective technological innovation, management and policy making -- will require increasingly powerful quantitative tools, building upon but expanding dramatically the approaches available for modeling, prediction and analysis of climate systems, ecosystems and socio-economic systems. If it was not obvious before, it has become abundantly clear in the current economic crisis that our ability to understand, predict and effectively modify the behavior of such complex systems is sorely limited, and indeed much research in dynamical systems also makes clear that there are inherent limits to predictability that lie beyond the capabilities of any modeling effort. That does not mean however that we cannot devise technologies and management schemes that build in design and adaptive features to minimize the potential for unwanted regime shifts. The science of robustness and resilience, of adaptability and vulnerability, and of “soft systems” engineering is developing in a variety of independent venues, from developmental biology to ecosystems to engineering design. The present workshop reflects is built on the premise that there could be substantial benefits from bringing these together to strengthen and further articulate the emerging field of sustainability science, and to identify crucial open research questions whose solution would advance the field by quantum levels. To provide focus, the workshop has been organized around four working groups address key aspects of sustainability, from the definitional to the predictive:<sup>23</sup>

## 5.1 Human well being and the natural environment

This is about delineating the dimensions of sustainability, and hence about the underlying interdependence of human well-being on the natural environment, and our (normative) preferences for having that interdependence result in some outcomes rather than others. It defines sustainability by starting with Brundtland, but then insisting that we develop an internally consistent framework for showing how use of, and even depletion of, aspects of the natural environment (seen as natural capital) can be consistent with sustainability so long as they are converted into other capital (e.g. manufactured, human, social) at appropriate rates. (This is what keeps ‘sustainability’ from being a euphemism for ‘environmental protection.’) Key questions involve the role of population growth (it should be per capita well-being, not ‘global’ or ‘national’ well being that we are interested in), time tradeoffs (discounting and intergenerational equity) and space tradeoffs (intra-generational equity), and the role of institutions, technology and knowledge more generally. The key concepts that need to emerge from and be defined by this discussion are “human well-being” and how it depends on nature, and “natural capital / ecosystem services” and how they contribute to human well-being. One good start has been made in providing such an internally consistent approach at the national level by Arrow et al. (2004) and later papers. We intend that the workshop should build on this work, and explore its applicability to multi-scale interactions.

## 5.2 Human-environment systems (HES) as complex adaptive systems

Even with one or more broad frameworks for sustainability in hand (say, the names of the variables, and our preferred states for those variables), we still need to understand how the system works. This is the intersection of the lower two circles of Fig. 3: coupled HE systems themselves and their dynamics both endogenous and in response to outside disturbance. Key questions involve the demographic, economic and technological drivers of such systems; vulnerability and resilience as emergent properties of such systems; their propensity for non-linear, threshold, or irreversible behaviors; and above all the ways in which their behaviors as systems emerge from adaptive actions by their constituent agents, interacting on a spatially heterogeneous tableau at multiple scales. The workshop aims to focus primarily on the subset of dynamics that require understanding of both H and E, as opposed to the dynamics that can be adequately explained by focusing on environmental systems or social systems alone, with the other treated merely as a boundary condition. This means that we need to understand the socioeconomic and technological dimensions of sustainability every bit as much as the biophysical. The central challenge here is to integrate advances in the theory and modeling of complex adaptive systems (CAS) with rich empirical work on the actual dynamics of coupled HES. The beginnings of a formal approach to this work have been set forth (Levin 1998, Levin 1999, Schellnhuber 1999), and a lot of recent qualitative empirical work – much of it supported by NSF’s biocomplexity and CHANS initiatives – has been drawn together (e.g. Liu et al., 2007). We hope that the workshop will integrate the existing conceptual and empirical perspectives on HES, and to explore the relevance of new tools in CAS for addressing their interactions.

### 5.3 Managing HES for sustainability

Knowing how HES work (i.e. the causal structures that determine their dynamics) is not the same as being able to make them work differently, using real instruments of technological and policy intervention that are available to us. The obvious part of this task is recognition of the basic reasons why such management is hard – the Malthus reason [population (and consumption) growing faster than environmental services], the Carson reason (externalities with unanticipated effects), and the Hardin reason (the commons). The not -quite -so- obvious part of the solution is management that is realistic about how real actors (as opposed to rational actors) see their worlds, is polycentric (i.e. different interventions at different scales, integrating the need for place-specificity and global public good provision), and is adaptive. The really hard part is doing this sort of management (which is a now common prescription for how to manage a global business) on the kind of complex adaptive system characterized in (2). For example, How can we bias technological innovation so that it is more supportive of sustainability? What should we do about mismatches between the characteristic scales of the relevant H and E systems? What does ‘adaptive management’ really mean in a world of unpredictable innovations, time lags, thresholds, and hysteresis, etc. The beginnings of a theory-grounded, empirically rich approach to these issues have been set forth that show great promise for small and medium scale resource commons (e.g. Ostrom, 2007). The workshop will seek to explore extensions of this approach to embrace more classic externality issues, especially as they extend across generations and large spatial scales.

### 5.4 Measuring and monitoring progress toward sustainability

Contemporary approaches to assembling the long term, spatially distributed empirical data sets that we need to test theories and guide policies of sustainability are little more than ad-hoc assemblies of what Danna Meadows used to call ‘beloved indicators’. The basic conceptual model outlined in (1) of the key state variables that determine sustainability, the fleshing out of the underlying determinants of those states discussed in (2), and the focus on key feedbacks that could guide adaptive management in (3) have latent in them the capacity to inform a true science of sustainability monitoring and measurement. This would require some additional heavy methodological lifting on multiscale issues, on aggregation problems and on indices. The foundations of what is needed have been explored in a number of NRC studies (e.g. NRC, 1999a; NRC, 1999b; NRC, 2000). Additional relevant work has begun to emerge in systematic efforts to document the state of ecosystems and their services as national and international scales (Carpenter et. al. 2009, H.J. Heinz Center, 2008). And a vigorous debate about metrics is presently taking forth in the context of the debate over climate change policies (Smith, 2008). Work in this area remains underdeveloped, however, and has not yet made adequate connections with emerging national (e.g. NEON) and global monitoring initiatives. We believe it should be possible to develop a common perspective on the challenge and barriers to progress. We hope that the workshop will go beyond that and draw on the understanding of human-environment systems as complex adaptive structures to say something original about the measuring and monitoring conundrum.

END

## Figures

Figure 1: A classification of the many framings of sustainable development (National Research Council (U.S.). Policy Division. Board on Sustainable Development., 1999 , p. 24)

	<b>FOR HOW LONG?</b>	
<b>WHAT IS TO BE SUSTAINED:</b>	25 years "Now and in the future" Forever	<b>WHAT IS TO BE DEVELOPED:</b>
<b>NATURE</b>		<b>PEOPLE</b>
Earth Biodiversity Ecosystems		Child Survival Life Expectancy Education Equity Equal Opportunity
<b>LIFE SUPPORT</b>	<b>LINKED BY</b>	<b>ECONOMY</b>
Ecosystem Services Resources Environment	<i>Only Mostly But And Or</i>	Wealth Productive Sectors Consumption
<b>COMMUNITY</b>		<b>SOCIETY</b>
Cultures Groups Places		Institutions Social Capital States Regions



Figure 2. Sustainability Science within a Divided World. A cartoon-like view of the sharp contrast in both perceptions and realities of resource distribution between countries of the 'north' and 'south'. The research of the “north” is global in orientation, theory-driven, and draws upon technological knowledge. The much smaller research effort of the “south” is local in orientation, action-driven, and draws upon traditional knowledge. The socio-economic, environmental, and knowledge dichotomies are exacerbated by the deepening 'digital divide'. (From Kates et al., 2001. Science 292: 641)

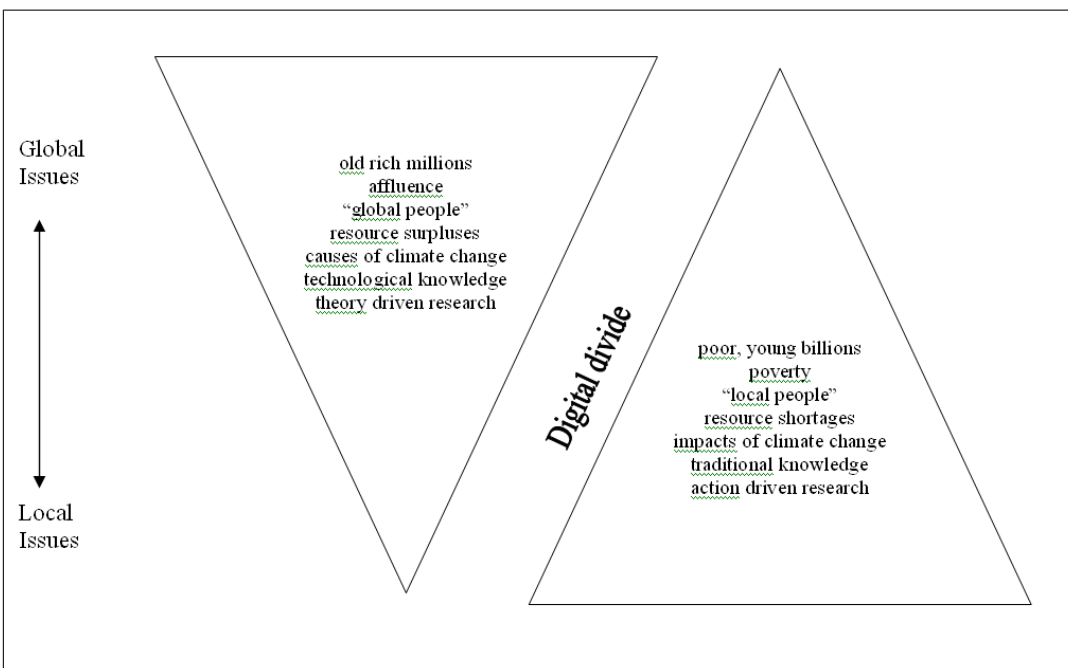

Figure 3: The domain of sustainability science

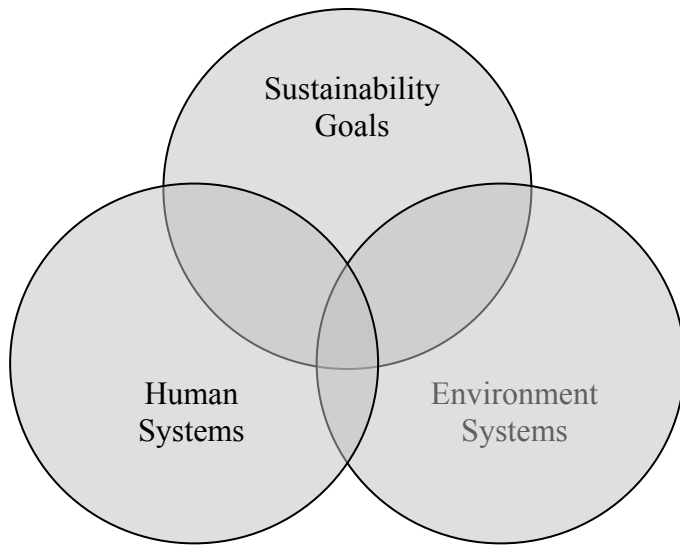

Figure 4: Interactions among the goals of sustainable development (derived from {National Research Council (U.S.). Policy Division. Board on Sustainable Development., 1999, p. 286, as modified by Pam Matson for AAAS 070214})

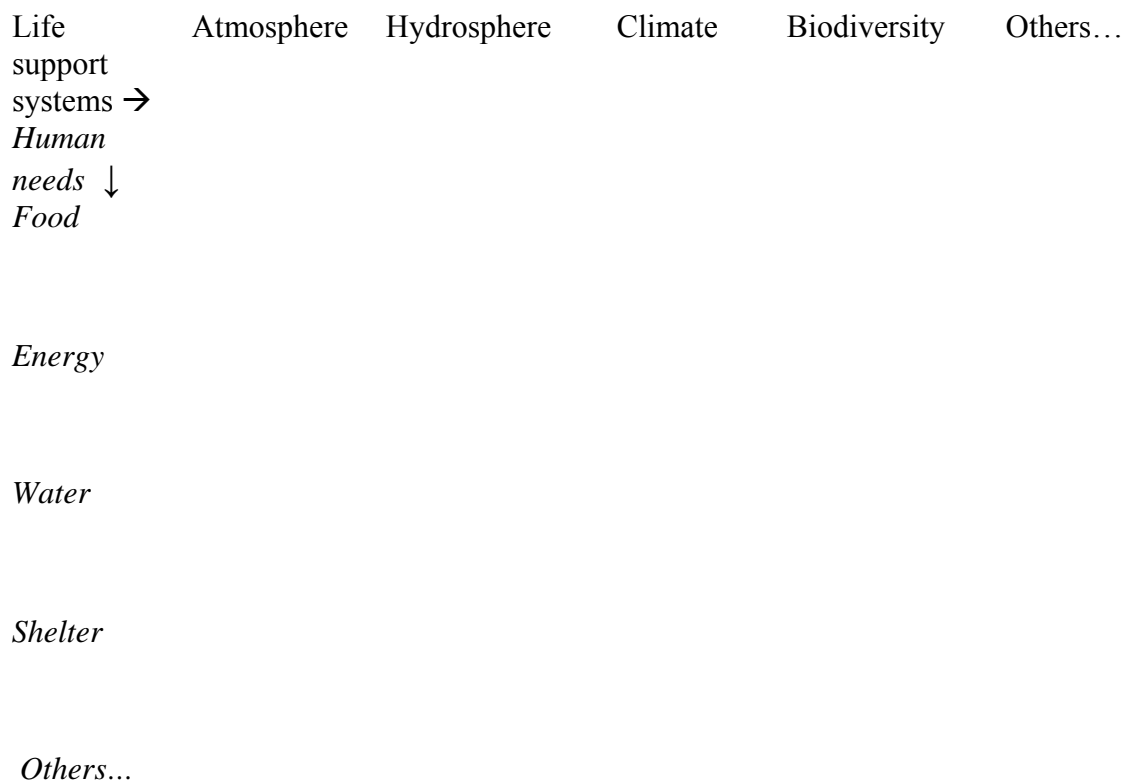

Figure 5: Complexities due to cross-scale phenomena in coupled human-environmental systems (Source: Clark, 1985)

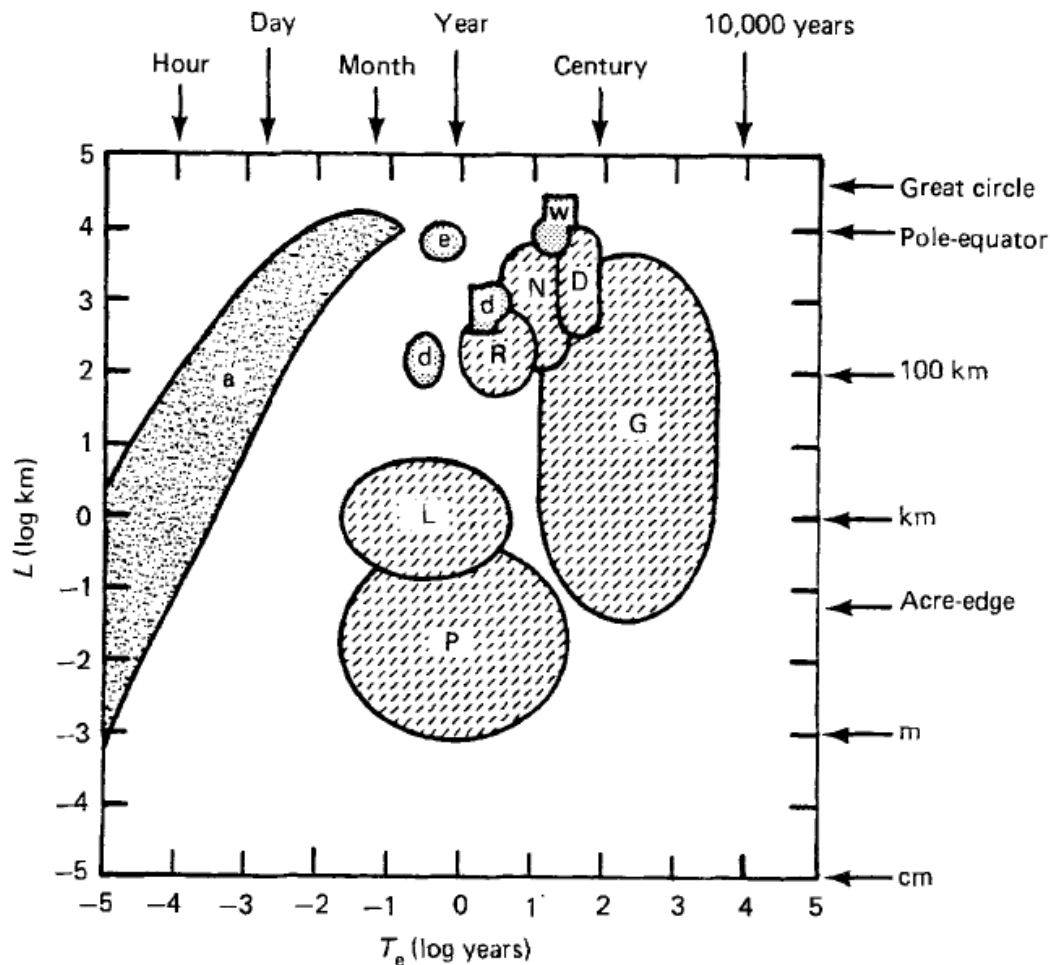
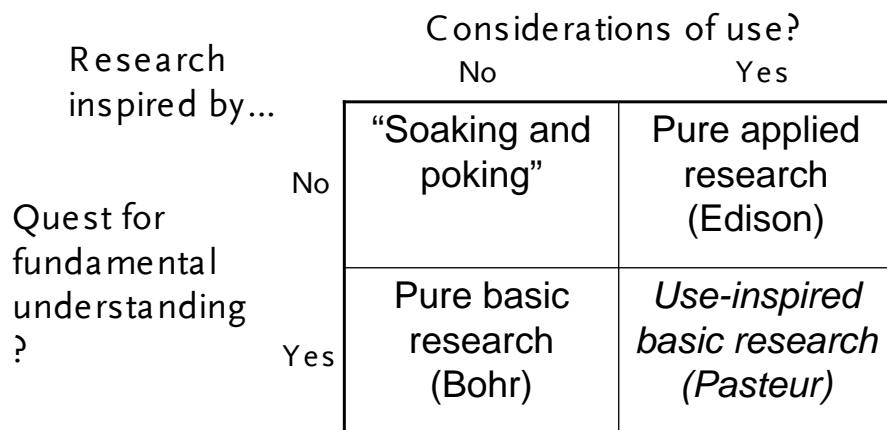

Fig. 7. Scales of interactions among climates, ecosystems, and societies. Stippled areas and lowercase letters represent climatic phenomena from Figure 3: (a) atmospheric phenomena, (e) El Niño, (d) drought, (w) warming. Diagonally shaded areas and uppercase letters represent social and ecological phenomena from Figure 6: (P) population ecology, (G) geographical ecology, (L) local farm activities, (R) regional agricultural development, (N) national industrial modernization, (D) global political/demographic patterns.

Figure 6:

## a) The Quadrant Model of Scientific Research



(redrawn from Stokes, 1997)

## b) Dynamic model of sustainability science and innovation

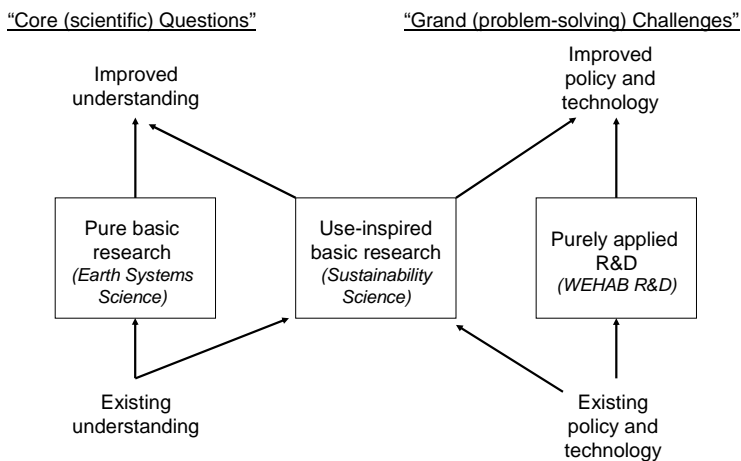

(redrawn from Stokes, 1997)

## ENDNOTES (incomplete references for paper)

---

<sup>1</sup> WCED, 1987, p. 8.

<sup>2</sup> These different perspectives are dealt with in more detail in Parris and Kates (2003) "Characterizing and measuring sustainable development" (ARER 28:559-86), and Leiserowitz, Kates and Parris (2006), "Sustainability values, attitudes and behaviors" (ARER 31: 413-444).

<sup>3</sup> WDR, 2007. Ch. 2 < [http://siteresources.worldbank.org/INTWDR2008/Resources/2795087-1192112387976/WDR08\\_04\\_ch02.pdf](http://siteresources.worldbank.org/INTWDR2008/Resources/2795087-1192112387976/WDR08_04_ch02.pdf)>

<sup>4</sup> World Bank, State Environmental Protection Administration of P.R. China. 2007. China cost of pollution: Physical and economic estimates. <http://go.worldbank.org/FFCJVBT40>. Note that according to the World Bank, pollution and resource degradation cost the median country of the world around 1.5% of its GNP/yr, with more than ¼ of countries losing >5% of GNP/yr (World Bank. 2007. World Development Indicators. Table 3.15.) See also Lebanon and Tunisia: [Owaygen, Marwan](#) ; [Larsen, Bjorn](#) ; [Sarraf, Maria](#). 2004. Cost of environmental degradation - the case of Lebanon and Tunisia. World Bank. <http://go.worldbank.org/WW9Z8RT870> ; Columbia: World Bank. 2006. Colombia - Mitigating environmental degradation to foster growth and reduce inequality. <http://go.worldbank.org/T3XEY9OGL0>; Pakistan. World Bank. 2006. The cost of environmental degradation in Pakistan : an analysis of physical and monetary losses in environmental health and natural resources. <http://go.worldbank.org/FBH9DFONU0>; Morocco: World Bank. 2003. The Kingdom of Morocco: Cost assessment of environmental degradation. Report No 25992-MOR. <http://siteresources.worldbank.org/INTMOROCCOINFRENCH/Data%20and%20Reference/20787156/259920ENGLISH010already0catalogued1.pdf> .

<sup>5</sup> Zhou Shengxian, Minister, SEPA, quoted in *International Herald Tribune*. 2006. China offers environmental plan; focus is sustainable development. (Feb. 15, 2006). See also Economist Intelligence Unit, Forecast for China, Oct. 31, 2007. (<http://www.economist.com/countries/China/profile.cfm?folder=Profile-Forecast>)

<sup>6</sup> Such efforts go back at least to Alexander von Humboldt and his work of the early to mid 1800s, and include George Perkins Marsh and more recent groups of researchers writing in *Man's Role in Changing the Face of the Earth*, William L. Thomas, Jr., ed., with Carl O. Sauer, Marston Bates, and Lewis Mumford (The University of Chicago Press, Chicago, 1956) and *The Earth as Transformed by Human Action*, B. L. Turner II, William C. Clark, Robert W. Kates, John F. Richards, Jessica T. Mathews, and William B. Meyer, eds. (Cambridge University Press, Cambridge, 1990), pp. 25-39. See the recent perspectives on human-environment studies by B. L. Turner II and Robert W. Kates ("Contested identities: Human-environment geography and disciplinary implications in a restructuring academy" and "Humboldt's dream, beyond disciplines, and sustainability science: Contested identities in a restructuring academy," *Annals of the Association of American Geographers* 92(1): 52-74 and 79-81, respectively).

<sup>7</sup> Third World Network of Scientific Organizations (TWNISO), <http://www.ictp.trieste.it/~twas/TWNISO.html>; Commission on Science and Technology for Sustainable Development in the South (COMSATS), <http://www.comsats.org.pk>; Society for Research and Initiatives for Sustainable Technologies and Institutions (SRISTI), <http://www.sristi.org/>; South Center at <http://www.southcentre.org/> (see particularly the *Elements for an Agenda of the South: Report of the NAM Ad Hoc Panel of Economists*, section 4 on "science and technology" at [http://www.southcentre.org/papers/nam/namfinal-02.htm#P287\\_47302](http://www.southcentre.org/papers/nam/namfinal-02.htm#P287_47302)). See also policy statements by the International Foundation for Science (IFS), <http://www.ifs.se/index.htm>; the International Science Programme (ISP), <http://www.isp.uu.se/Home.htm>; and the Millennium Science Initiative (MSI), [http://www.msi-sig.org/MSI-SIG\\_summary.htm](http://www.msi-sig.org/MSI-SIG_summary.htm).

<sup>8</sup> African Academy of Sciences' *Tunis Declaration: Millennial Perspective on Science, Technology and Development in Africa and its Possible Directions for the Twenty-first Century* (Fifth General Conference of the African Academy of Sciences, Hammamet, Tunisia, 23-27 April 1999), [http://www.unesco.org/general/eng/programmes/science/wcs/meetings/afr\\_hammamet\\_99.htm](http://www.unesco.org/general/eng/programmes/science/wcs/meetings/afr_hammamet_99.htm).

<sup>9</sup> H. J. Schellnhuber and V. Wenzel, eds. 1998. "Earth System Analysis: Integrating Science for Sustainability." Berlin: Springer-Verlag; European Commission. 1998. "Fifth Framework Programme: Putting Research at the Service of the Citizen," <http://www.cordis.lu/fp5/src/over.htm>; S. Funtowicz and M. O'Connor, eds. 1999. "Science for sustainable development." Special issue of *International Journal of Sustainable Development* 2: 3.

<sup>10</sup> C. E. Rocha-Miranda, ed. 2000. "Transition to Global Sustainability: The Contributions of Brazilian Science." Rio de Janeiro: Academia Brasileira de Ciências, <http://sustainabilityscience.org/keydocs/brazilsci.htm>; Series of Annual Reports by the German Advisory Council on Global Change (WGBU), particularly its *World in Transition: The*

*Research Challenge, Annual Report 1996*. Berlin: Springer-Verlag, 1997, [http://www.wbgu.de/wbgu\\_publications.html](http://www.wbgu.de/wbgu_publications.html); United States National Research Council, Board on Sustainable Development. 1999. *Our Common Journey: A Transition Toward Sustainability*. Washington, D.C.: National Academy Press, <http://www.nap.edu/catalog/9690.html>; Science Council of Japan. 2000. *Towards a comprehensive solution to problems in education and the environment based on a recognition of human dignity and self-worth*. Science Council of Japan; Royal Society. 2000. *Towards sustainable consumption: A European perspective*. London.

<sup>11</sup> UNESCO. 1999. *World Conference on Science for the 21<sup>st</sup> Century: A new commitment*.

<http://www.unesco.org/bpi/science/content/press/anglo/4.htm>.

<sup>12</sup> The Global Environmental Change Programmes have made "global sustainability" a center point of their research planning for the coming years (see IGBP. 2001. *Global change and the earth system: A planet under pressure*. IGBP Science Series, No. 4. Paris: ICSU, [http://www.igbp.kva.se/uploads/ESO\\_IGBP4.pdf](http://www.igbp.kva.se/uploads/ESO_IGBP4.pdf); and IGBP. 2001. *The Amsterdam Declaration on Global Change – Challenges of a Changing Earth*. Global Change Open Science Conference, Amsterdam, 13 July 2001, <http://www.sciconf.igbp.kva.se/fr.html>; Paris Workshop organized under the auspices of the Global Change Science Programmes on *Sustainable Development: The Role of International Science*. Paris, 4–6 February, 2002, (Bonn, IHDP, cited here as Global Change, 2002).

<sup>13</sup> Robert Watson, John A. Dixon, Steven P. Hamburg, Anthony C. Janetos, and Richard H. Moss. 1998. *Protecting Our Planet, Securing Our Future*. Nairobi: UN Environment Programme, <http://www-esd.worldbank.org/planet/>; Intergovernmental Panel on Climate Change. 2001. *Special Report on Climate Change and Sustainable Development, IPCC Plenary Seventeenth Session*. Nairobi, 4–6 April 2001, <http://www.ipcc.ch/meet/p17.pdf>; Millennium Ecosystem Assessment, <http://www.millenniumassessment.org/en/index.htm>. [Something needed on Millennium Ecosystem Assessment and Sustainability]

<sup>14</sup> These included

\* a symposium hosted by the World's Scientific Academies' *Transition to Sustainability in the 21st Century* (Tokyo Summit of May 2000), [http://www4.nationalacademies.org/intracad/tokyo2000\\_nsf/all/home](http://www4.nationalacademies.org/intracad/tokyo2000_nsf/all/home);

\* a series of regional workshops and consultations hosted by the international Initiative on Science and Technology for Sustainability (<http://sustainabilityscience.org/ists>; summarized in ICSU/ISTS/TWAS 2002. "Science and Technology for Sustainable Development". ICSU Series on Science and Technology for Sustainable Development, No. 9);

\* International Council for Science. 2002. *Report of the Scientific and Technological Community to the World Summit on Sustainable Development*. ICSU Series on Science for Sustainable Development, No. 1. 20pp, <http://www.icsu.org/Library/WSSD-Rep/vol1.pdf>. ICSU and WFE0 also prepared the follow-up document "Science and technology as a foundation for sustainable development: Summary by the scientific and technological community for the multistakeholder dialogue segment of the WSSD PrepCom IV meeting. (Report available at [http://sustainabilityscience.org/ists/synthesis02/icsu\\_s+t\\_2pager\\_wssd-prepcom4.pdf](http://sustainabilityscience.org/ists/synthesis02/icsu_s+t_2pager_wssd-prepcom4.pdf); cited here at ICSU et al., 2002b).

<sup>15</sup> The contributions of these and other organizations working on improving the linkages between science and technology on the one hand, and the sustainable development agenda on the other, can be followed through the on-line "Forum on Science and Innovation for Sustainable Development" (<http://sustainabilityscience.org>) and the "Science and Development Network" (<http://scidev.net>). See also J. Jaeger. 2009. Sustainability science in Europe. (Unpublished ms commissioned by the European Commission.

<sup>16</sup> This matrix format was originally developed by Paul Crutzen and Tom Graedel in their contribution to my 1986 book "Sustainable Development of the Biosphere," modified by the NRC Board on Sustainable Development for its 1999 "Our common future" study, and applied to the present context by Pam Matson at the San Servolo workshop on Grand Challenges of Sustainability and, subsequently, her plenary address at AAAS.

<sup>17</sup> <http://www.agassessment.org/>

<sup>18</sup> I've used my own old material here, just because it's the one I know the genesis of that addresses temporal and spatial scales of social and environmental phenomena in the same study. [William C. Clark. 1985. Scales of climate impacts. *Climatic change* 7(1): 5-27.] But there are other candidates, including Fig. 14.13 in the Chapin/Matson/Mooney book on *Terrestrial Ecosystem Ecology*, and several parts of the Moran/Ostrom book "Seeing the forest and the trees," eg. Fig. 5.2 and several relevant figures and accompanying text of chapter 3 (Green, Schweick and Randolph), though these are more relevant to method than to causation. There is also a book on *BRIDGING SCALES AND KNOWLEDGE SYSTEMS: Concepts and Applications in Ecosystem Assessment*, edited by Walter Reid, Fikret Berkes, Thomas Wilbanks. 2006. Island Press that we may want to consult. Other suggestions?

<sup>19</sup> Many references to boundary work and adaptive management possible here. Also the older Parson-Clark paper from Gunderson and Holling on sustainable development as social learning. Favorites?

<sup>20</sup> This text is taken in large part from Clark, 2007 (PNAS editorial on Sustainability Science).

<sup>21</sup> Stokes, 1997, p. 13.

<sup>22</sup> The text that follows is drawn from the Levin-Clark proposal to NSF for the present workshop.

<sup>23</sup> References cited in the remainder of this section include:

Arrow K., L. Goulder, P. Dasgupta, G. Daily, P. Ehrlich, G. Heal, S. Levin, K.-G. Maler, S. Schneider, D. Starrett, and B. Walker. (2004) Are we consuming too much? *Journal of Economic Perspectives* 18(3): 147-172.

Carpenter, S.R., *et al.* (2009) Science for managing ecosystem services: Beyond the Millennium Ecosystem Assessment. *PNAS* 106(5): 1305-1312.

The H. John Heinz III Center for Science, Economics, and the Environment. (2008) *The State of the Nation's Ecosystems: Measuring the Land, Waters, and Living Resources of The United States*. Washington, DC: Island Press.

Levin, S.A. (1998) Ecosystems and the biosphere as complex adaptive systems. *Ecosystems* 1: 431-436.

Levin, S.A. (1999) *Fragile Dominion: Complexity and the Commons*. Reading, MA: Perseus Books Group.

Liu, J.L., T. Dietz, S.R. Carpenter, M. Alberti, C. Folke, E. Moran, A.N. Pell, P. Deadman, T. Kratz, J. Lubchenco, E. Ostrom, Z. Ouyang, W. Provencher, C.L. Redman, S.H. Schneider, and W.W. Taylor. (2007) Complexity of coupled human and natural systems. *Science* 317(5844): 1513-1516.

Ostrom, E. (2007) A diagnostic approach for going beyond panaceas. *Proceedings of the National Academy of Sciences* 104: 15181-15187.

National Research Council (U.S.), Policy Division, Board on Sustainable Development. (1999a) *Our Common Journey: A Transition Toward Sustainability*. Washington, DC: National Academies Press. Available at: [http://www.nap.edu/catalog.php?record\\_id=9690](http://www.nap.edu/catalog.php?record_id=9690).

National Research Council, (U.S.), Panel on Integrated Environmental and Economic Accounting. (1999b) *Nature's Numbers: Expanding the National Economic Accounts to Include the Environment*, ed. W.D. Nordhaus and E.C. Kokkelenberg. Washington, DC: National Academies Press. Available at: [http://www.nap.edu/catalog.php?record\\_id=6374](http://www.nap.edu/catalog.php?record_id=6374).

National Research Council (U.S.), Committee to Evaluate Indicators for Monitoring Aquatic and Terrestrial Environments. (2000) *Ecological Indicators for the Nation*, ed. G. Orians. Washington, DC: National Academies Press. Available at: [http://www.nap.edu/catalog.php?record\\_id=9720](http://www.nap.edu/catalog.php?record_id=9720)

National Research Council (U.S.). (2003) *Neon: Addressing the Nation's Environmental Challenges*. Washington, DC: National Academies Press. Available at: [http://www.nap.edu/catalog.php?record\\_id=10807](http://www.nap.edu/catalog.php?record_id=10807).

Schellnhuber, H.J. (1999) "Earth system" analysis and the second Copernican revolution. *Nature* 402(6761): C19-C23.

Smith, V.K. (2007) Reflections on the literature. *Review of Environmental Economics and Policy* 1(2): 300-318.



**HUMAN WELL BEING AND THE NATURAL ENVIRONMENT:  
A FOCUS ON ECOSYSTEM SERVICES  
Ann P. Kinzig**

*A Background Paper prepared for the “Towards a Science of Sustainability” Conference  
30 Nov to 2 December, Warrenton, VA*

I have been asked to be both brief and provocative in this paper; the first makes the second easy, as I will not be able to fully articulate or defend my positions in the space allotted. My brief is to cover “human well being and the natural environment”; this leads me naturally to the topic of ecosystem services, since they are, by definition, a description of the benefits people receive from ecological systems.

Fully elucidating the challenge of understanding ecosystem services requires drawing on basic ecological and economic theory, understanding complex adaptive systems and resilience, and getting a handle on how people’s preferences change over time and what that means for sustainability. Addressing all of these areas is beyond the scope of this paper, and so I choose to address three issues below: (a) the problem of people, in theory, in theory; (b) the problem of biodiversity; and (c) the problem of scale. I am assuming that much of interest to the topic of ecosystem services will appear in the other white papers, though they may not purport to directly address this topic.

This paper is lightly referenced; for two relatively short but important and authoritative papers on a similar topic, I would recommend Kates *et al.* 2001 and Carpenter *et al.* 2006. There are several longer pieces outlining research priorities on ecosystem services and sustainability more generally, the most cited of which are the Millennium Ecosystem Assessment (MA 2005) and *Our Common Journey* (NRC 1999).

I choose to focus on ecosystem services because scientists have been asserting the importance of nature for human well being for quite some time (e.g., Marsh 1864 through to Daily 1997), culminating in the recent comprehensive synthesis on the state of knowledge (MA 2005). And yet scientists also assert that much natural-resource management still fails to fully account for the goods and services people derive from the world’s biological resources. There are several reasons for this, including: (a) scientists have failed to adequately articulate the value of nature, or have overstated its value; (b) private decision makers do not fully recognize the value of nature or are ‘authorized’ by law or custom to ignore the effect of their actions on nature; or (c) policy makers do not recognize the value of nature, or else lack the policy instruments or management strategies needed to protect or enhance the value of nature. There are undoubtedly elements of truth in each of these; I focus here primarily on (b) and (c), but we should not rule out (a) (particularly the second part of (a)) as a possibility.

### *The Problem of People, In Theory*

The MA recognized four distinct types of ecosystem services—the provisioning services (e.g., food, fiber, fuel, genetic resources); the regulating services (e.g., climate regulation, natural-hazard regulation, disease regulation); cultural services (e.g., recreation, cultural landscapes, aesthetic or spiritual experiences); and supporting services (e.g., nutrient cycling, soil production). The fourth of these categories is unique in that supporting services are required for the production of all other services.

Ecosystem services are only services to the extent that people value them, either directly or indirectly. The services in the first three categories tend to be directly valued (to greater or lesser extent depending on the conditions people experience) while those in the fourth category tend to be indirectly valued (valued not for their own sake, but because they contribute to another valued service).

Quantifying the flow of ecosystem services in three of the categories, then, requires understanding the supporting services. Supporting services map reasonably directly to the ecosystem functions of primary production, soil production, and nutrient and resource cycling. There is a long literature on the relationship between biodiversity and ecosystem functioning, and hence between biodiversity, supporting services, and all other services. The (very short) summary is that higher levels of biodiversity (often measured by plant species richness, but sometimes measured as functional diversity or trophic diversity) usually enhance ecosystem functioning (see, e.g., Tilman and Downing 1994; Naeem *et al.* 1996; Kinzig *et al.* 2002).

There are several problems with translating these results to managers and decision makers. The most important is that almost all of the studies (both theoretical and empirical) have started by randomly assembling communities in patches, or creating landscapes with random configurations of different patch types. But Nature, even when left to her own devices, does not randomly assemble communities or landscapes (see Levin 1999); things are potentially even less erratic when humans enter the mix. What we have is a theory that connects ecosystem functioning to all types of communities or landscapes we can imagine, however probable or improbable they may be. What we need is a theory that connects functioning to the types of communities and landscapes people actually create; can elucidate the likely trajectories of those human-created communities and landscapes; and can attach movements along these trajectories to changes in ecosystem services and human well being.

We are making some progress on this in the (relatively new) fields of landscape ecology and urban ecology, but much more needs to be done (Collins *et al.* 2000). In particular, we need to revisit ecological theory, much of which was fashioned when people were taken to be “outside” of nature rather than an integral part of it, to ask which of these theories actually extend to human-altered or human-dominated systems,

and which need to be revisited. Ecologists will have to collaborate with a wide range of social scientists in order to do this effectively.

### *The Problem of Biodiversity*

Many of the conceptual frameworks demonstrating the connection between the world's ecological systems and ecosystem services take biodiversity as the starting point for delivery of services (see, for instance, Carpenter *et al.* 2006 Figure 1). While biodiversity of all types (genetic, population, species, habitat, landscape) is undoubtedly important for many ecosystem services, a narrow focus on biodiversity is misleading. Many ecosystem services depend on ecological configurations not covered by the concept of biodiversity (e.g., biomass, percent cover, or simply the traits of the dominant species—see, for instance, Diaz *et al.* 2007). In some cases, management focused on maximizing biodiversity may actually undermine other ecosystem services (see Chan *et al.* 2006).

Some ecosystem services “trade off” against each other. For instance, enhancing provisioning services often comes at the expense of disease regulation or recreational opportunities. Maximizing carbon sequestration in a forest may actually degrade water quality or the maintenance of genetic diversity. If all services were directly supported by the biological diversity present in the system, these trade-offs would not occur.

In other cases, ecosystem services might be expected to complement each other, so that enhancing one would provide the ancillary benefit of enhancing its complements; this may work either through components of biodiversity or other features of the ecological system.

In order to understand which services trade-off against each other and which are complements, ecologists need to elucidate the ecological configurations that contribute to each service, and to show how marginal changes in those configurations alter the flow of services delivered. We are nowhere near having the frameworks we need to effectively analyze this. Focusing too narrowly on biodiversity may actually be impeding progress. We need to return to an earlier focus on ecological pattern more generally (Levin 1992), and ask which structures, traits, and configurations underpin each service. Those services largely dependent on the same patterns will complement each other; those services dependent on patterns that cannot simultaneously be realized will trade-off against each other. Whether services complement each other or trade-off against each other may well depend on the ecosystem in question (e.g., grassland or forest) and will certainly depend on scale (see below).

Understanding these trade-offs and complements will be a critical part of decision making and management. We cannot afford, through our rhetoric or conceptual frameworks, to convey the idea that the best management practices will

simply focus on enhancing biodiversity. We need to convey a much more sophisticated understanding of ecological pattern and process.

As scientists, we should also be aware that our focus on biodiversity is, in part, subjective. Making biodiversity a target of management or conservation is no more scientifically objective than making various ecosystem services the targets of those same activities. It is not our job as scientists to tell the world what they *should* value, but whether and how they can achieve the ends they *do* value. Biodiversity conservation should be the means to an end (“I can demonstrate that to get the thing you want, you need these aspects of biodiversity”) rather than an end in itself (“saving biodiversity is inherently important”) (unless, of course, society has embraced the goal of saving biodiversity for its own sake). (Activists and advocates have greater scope for making the subjective arguments.) Decision makers at all levels recognize that this focus on biodiversity is often about values and not about science; when we are not careful in distinguishing the two we not only “oversell” the value of biodiversity, we risk our credibility.

### *The Problem of Scale*

A particular patch of land (or water) delivers services at a variety of scales, from local to global. The value of the stream of services delivered to different beneficiary communities will change not only because the “strength” of the service itself will vary by distance from the reference patch, but because the economic and cultural attributes of different communities will cause them to have different preferences for various services. The costs of supplying a stream of services (including the “opportunity cost” associated with forgoing alternative land-use configurations) also vary by scale, and are often primarily born locally (see Wells 1992). Therefore, local and distant beneficiaries of ecosystem services would almost always identify different “optimal” landscape configurations for balancing costs and benefits and delivering preferred services.

Many of the tools designed to aid decision makers in incorporating the value of natural capital into decisions focus on those benefits that can be “co opted” by the constituents within a particular political unit (county, state, nation, etc.). They thus ignore the service delivered outside of those political boundaries, effectively setting their value to zero in decision making. This is one of the central conundrums of the management of natural capital—so much of its value is global in nature (deriving to all of humanity) and so little of it is managed with that scale in mind.

This conundrum suggests two priority areas for research. The first is to identify where the biggest “gaps” are between global (or regional) and local (or national) interests. The second is to identify the incentives or mechanisms needed to bridge that gap.

In the first instance, we need to identify those ecological and social conditions that cause the biggest gaps to emerge. (Where global and national interests largely coincide, perhaps because of significant complementarity, for instance, between those services valued locally and those valued globally, little needs to be done. It can be left to local decision makers to supply the larger public good.) This in part requires assessing the spatial patterns of delivery of the ecosystem services included in the MEA, and in part identifying the preferences and values of different sets of beneficiaries. Such gap identification could potentially shift current priorities for international investments in conservation and environment.

Payments for ecosystem services (PES) have emerged as a favored mechanism for bridging these gaps, with (often distant) beneficiaries paying (often local) stewards for a contracted stream of services (Engel *et al* 2008). PES are often being promoted without sufficient attention to their limitations, or how they might be designed to avoid those limitations. PES are often established for single services (e.g., carbon sequestration). Elevating one service above all others risks seriously sub-optimal natural resource management. (We have seen this repeatedly in agricultural systems, where the emphasis on yield as the only service of interest has created such externalities as disease outbreaks and eutrophication. If the services of disease regulation and nutrient cycling were also valued in agricultural management, our agricultural systems might look very different.) Since the time scales involved with fundamentally altering ecological configurations and thus flows of services are often measured in decades (and much of the theory surrounding markets assumes infinitely “liquid” capital and a much greater ability to respond rapidly to changing conditions), we should think seriously about how a piecemeal development of markets for ecosystem services will affect future flows of those services. Is it really wise, for instance, to develop a market for carbon before markets for other critical ecosystem services are ready for deployment? Do we risk forests that are much like today’s agricultural systems, focused on a single service at the expense of others? Can we effectively deviate from that path as other services become valued?

Additionally, markets inherently favor those with the ability to pay. Development of a set of markets for a suite of ecosystem services, then, risks skewing the services delivered towards those favored by the rich. And yet the poor, particularly the rural poor, are almost always the ones most dependent on (a particular set of) ecosystem services for survival. Thus, PES can’t and shouldn’t work in isolation. Allocation of property rights, land-use planning and restrictions, and trade policies will all be critical components of managing for ecosystem services and natural capital. We need a better assessment of how these different policy tools and institutions interact in different social and ecological settings to determine the best approaches to take.

### **Additional Areas of interest**

Space precludes highlighting all of the research areas of interest, but I would like to briefly touch on three here.

*Inclusive Wealth*

The wealth of a nation (or any human community) should not be determined by only financial or built capital, but by natural, human, and social capital as well. If a measure of inclusive wealth had as much power in political rhetoric as GDP has today, one can easily imagine that the world would make much better decisions about natural resource management. I hope and assume that Partha Dasgupta will develop this idea in much more detail in his own white paper. I would just add that we need better research not only into *how* to develop measures of inclusive wealth, but in how they might come to be accepted as more appropriate measures of the wealth of a nation. The recent economic crisis may provide a real window of opportunity for rethinking standard measures of wealth and well being—how do we take advantage of that?

*Early warning indicators of change*

A “holy grail” in resilience, robustness, and complex-adaptive-system studies is to be able to anticipate irreversible change before it occurs, and while there is still time to act to avoid it (or at least prepare for it). Unlike inclusive wealth measures (where we have some reasonable indices), we still don’t have reasonable “early warning” indicators of change (though there have been heroic efforts in this direction—see Scheffer 2009 for a nice review). I hope this idea is developed further in the white papers by Levin, Carpenter, or others; either way, I hope it is a topic for discussion at the meeting.

*Social norms*

Many commentators have suggested that achieving sustainability requires changing social norms. A change in social norms is assumed to change behaviors for “the better”. But (to oversimplify) there are two ways to change behaviors. One is through a change in norms (e.g., it is OK to ignore your dinner companion while have a cell-phone conversation at the table). The other is through a change in regulations or incentives that causes people to behave as though they hold a particular set of values even if they don’t (e.g., banning cell-phone conversations in restaurants). In the latter case, social norms often shift to match behaviors, rather than having behaviors shift to match norms. (A better example of this is recycling, not cell-phone behavior. Many people initially resisted recycling, but did it anyway because of financial penalties; now many instinctively recycle even in the absence of financial penalties.) Ultimately a shift in norms is required to make change long lasting, but we need a better understanding of how such shifts in norms play out in the domain of the environment, and the role that policies and regulations might play (do they create or respond to these shifts?). The relationship will undoubtedly depend on social and cultural context.

## REFERENCES

- Carpenter, S.R., R. DeFries, T. Dietz, H.A. Mooney, S. Polasky, W.V. Ried, & R. Scholes. 2006. Millennium Ecosystem Assessment: Research needs. *Science* 314:257-8.
- Chan, K. M. A., M. R. Shaw, D. R. Cameron, E. C. Underwood, and G. C. Daily. 2006. Conservation planning for ecosystem services. *Public Library of Science Biology* 4(11): e379
- Collins, J.P., A. Kinzig, N.B. Grimm, W.F. Fagan, D. Hope, J. Wu, and E.T. Borer. 2000. A new urban ecology. *American Scientist* 88:416-425.
- Daily, G., ed. 1997. *Nature's Services: Societal Dependence on Natural Ecosystems*. Island Press, Washington, DC.
- Diaz, S., S. Lavorel, F. de Bello, F. Quétier, K. Grigulis, & T.M. Robson. 2007. Incorporating plant functional diversity effects in ecosystem service assessments. *Proceedings of the National Academy of Sciences* 104:20684-9.
- Engel, S., S. Pagiola, & S. Wunder. 2008. Designing payments for environmental services in theory and practice: An overview of the issues. *Environmental Economics* 65(4):663-74.
- Kates, R.W., and 22 others. 2001. Sustainability science. *Science* 292(5517):641-2.
- Kinzig, AP, SW Pacala, D Tillman, eds. 2002. *The Functional Consequences of Biodiversity*. Princeton University Press, Princeton, NJ.
- Levin, S.A. 1992. The problem of pattern and scale in ecology: The Robert H. MacArthur Award Lecture. *Ecology* 73(6):,1943-67.
- Levin, S.A. 1999. *Fragile Dominion: Complexity and the Commons*. Perseus Publishing.
- Marsh, G.P. 1864. *Man and Nature*. Charles Scribner, New York, NY.
- Millennium Ecosystem Assessment (MA) 2005. *Ecosystems and Human Well-Being: Synthesis*. Island Press, Washington, DC.
- Naeem, S., K. Hakannsson, J. Thompson, J.H. Lawton, and M.J. Crawley. 1996. Biodiversity and plant productivity in a model assemblage of plant species. *Oikos* 76:259-264.
- National Research Council (NRC). 1999. *Our Common Journey: A Transition Towards Sustainability*. National Academy Press, Washington, DC.
- Scheffer, M. 2009. *Critical Transitions in Nature and Society*. Princeton University Press, Princeton, NJ.

- Tilman, D. and J.A. Downing. 1994. Biodiversity and stability in grasslands. *Nature* 367:363-5.
- Wells, M. 1992. Biodiversity conservation, affluence, and poverty: mismatched costs and benefits and efforts to remedy them. *Ambio* 21(3):237-43.



## **Sustainable Development and Comprehensive Wealth\***

by

Partha Dasgupta

Faculty of Economics, University of Cambridge

November 2009

\* These Notes have been prepared for a National Science Foundation meeting on *Sustainability Science*. The ideas discussed here are developed far more fully by Jon Bongaarts, Steven Carpenter, William Clark, Partha Dasgupta, Robert Kates, Pamela Matson, Elinor Ostrom, John Schulhuber, and Billy Turner III, who are currently at work on a manuscript with the title, *A Short Introduction to Sustainability Science*. Our book will be ready for distribution in early Spring, 2010.

Economic evaluation is undertaken in response to one or more of the following questions: (A) How is the economy doing? (B) How has it performed in recent years? (C) What is its performance likely to be under "business as usual"? (D) How is it likely to perform under alternative policies? (E) What policies should be pursued there?

National income accounts offer information that are relevant for answering question (A), although it will be argued here that they do so in an unsatisfactory way. Policy evaluation, including project evaluation (or social cost-benefit analysis), is a response to questions (D) and (E), the aim being to evaluate an economy at a point in time before and after a hypothetical perturbation has been made to it (the perturbation being a policy change or an investment project). In contrast, assessing whether economic development is, has been, or will be *sustainable*, is a response to questions (B) and (C). The idea there is to evaluate the change that occurs in an economy with the passage of time.

The literature on sustainable development grew in response to the systematic neglect of natural capital in studies of contemporary economic development. The worry was that the pattern of economic growth in recent decades is not sustainable because of a decline in stocks of natural resources and a deterioration in the quality of various environmental services that have accompanied the growth process. As sustainable development must refer to a path of development that sustains *something*, the problem has been to identify what that "something" should be.<sup>1</sup>

### **The Brundtland Conception**

World Commission on Environment and Development (1987) - commonly known as the Brundtland Commission Report - defined *sustainable development* as "... development that meets the needs of the present without compromising the ability of future generations to meet their own needs." In this conception sustainable development requires that, relative to their populations, each generation should bequeath to its successor at least as large a *productive capacity* as it had itself inherited.

It will be noticed that the requirement is derived from a relatively weak notion of intergenerational equity. Sustainable development demands that future generations have no less of the means to meet their needs than we do ourselves; it demands nothing more. It doesn't, for example, demand that development be optimal. So, the requirement that economic development process is *sustainable* is different from the demand that it ought to be *optimal*.

That said, the Brundtland Commission's definition of sustainable development suffers from two weaknesses. First, it offers no guidance on how the various components of an

---

<sup>1</sup> Pezzey (1992) and Parris and Kates (2006) have constructed taxonomies of the various ways in which "sustainable development" could be defined. In these Notes I don't offer a taxonomy, because we now have a settled view of the matter (see Arrow *et al.*, 2004; World Bank, 2006).

economy's productive capacity are to be aggregated. Secondly, the definition mentions "needs", rather than the "well-being", of future generations. As sustaining intergenerational well-being is likely to demand a lot more from the current generation than merely meeting the needs of future generations, one can argue that the Brundtland Commission was proposing a somewhat undemanding criterion for sustainable development.

An object is "sustained" when it doesn't diminish over time. Welfare economics and moral philosophy work with the notion of human well-being. Needs are derived from that notion. Which means that in formulating the concept of sustainable development, the right place to start is the notion of human well-being across generations. So, in what follows *we take sustainable development to mean a path of development that sustains intergenerational well-being*.

Formally, suppose  $V(t)$  denotes intergenerational well-being at time  $t$ . Then we say that economic development is sustained at  $t$  if

$$dV(t)/dt \geq 0. \quad (1)$$

Sustainable development over an interval of time can be defined analogously (Dasgupta, 2001).

No national accountant would risk measuring intergenerational well-being: there are deep measurement problems. Which is why condition (1) cannot be put to empirical work directly. The trick is to construct a numerical index that is easier to measure than  $V$ , but can nevertheless act as a surrogate for  $V$ . By a "surrogate", I mean a numerical index that moves in the same way over time as  $V$ .

Formally, let  $W(t)$  be a scalar. We say that  $W(t)$  can act as a surrogate for  $V(t)$  if,

$$dW(t)/dt \geq 0 \text{ if and only if } dV(t)/dt \geq 0. \quad (2)$$

Now suppose  $W$  is not as difficult to estimate as  $V$ . Then, rather than  $V$ , we should use  $W$  as our "sustainability index". *We confirm below that a comprehensive measure of an economy's wealth, estimated in terms of shadow prices, is the right surrogate for intergenerational well-being.*

### **Intergenerational well-being**

$V$  is an aggregate of the various *constituents* of human well-being. They include health, education, family life, purposeful work, meaningful leisure - more generally, the extent to which life flourishes. We take it that  $V$  includes the well-beings not only of the members of the current generation, but of future generations as well.

**Example of  $V$ :** In economics the most commonly deployed  $V$  is a generalized version of classical utilitarianism. To fix ideas, assume that population is constant. Let  $\underline{C}(s)$ ,  $\underline{K}(s)$ , and  $\underline{A}(s)$  respectively, be the vectors of consumption services, capital stocks, and activities people enjoy at date  $s$ . And let  $U(\underline{C}(s), \underline{K}(s), \underline{A}(s))$  be the flow of aggregate well-being at  $s$ . Then,

$$V(t) = \int_t^{\infty} [U(\underline{C}(s), \underline{K}(s), \underline{A}(s))] e^{-\delta(s-t)} ds, \quad \delta \geq 0. \quad (3)$$

$\delta$  is the well-being discount rate. An *economic forecast* at  $t$  is the pair of vector functions  $\{\underline{C}(s), \underline{K}(s), \underline{A}(s)\}$ , for  $s \geq t$ .

It could seem odd that we are including capital stocks directly in the well-being function,

$U$ . However, there are many types of natural capital that are not only instrumentally valuable (e.g., wetlands offering pollination services), but are directly enjoyable (e.g., places of scenic beauty that may include the wetlands; sacred groves).

### **Economy-Wide Productive Base**

Recall that the Brundtland Commission didn't mention the constituents of well-being. That meant the Commission didn't elaborate on the structure of  $V$ . Instead, they alluded to the *means* of attaining well-being. Let us refer to the set of factors that produce well-being the economy's *productive base*. Earlier we referred to an economy's productive *capacity*, by which we meant the magnitude of its productive base. So, an economy's productive base is composed of the "means" by which  $V$  is produced.

What does a productive base consist of? It is useful to divide it into *capital assets* and *institutions*. The long list of assets in a modern economy includes not only reproducible capital (roads, buildings, machines), human capital (health, education, skills), and publicly available knowledge (science and technology), but also the size and composition of its population and natural capital (fisheries, forests, the atmosphere (ecosystems, more generally), oil and natural gas, and so forth). We understand institutions to mean the social arrangements governing human activities. They include commonplace organizational structures (firms, markets, government, households), but also more elusive forms of arrangement that are variously called "social capital" (e.g., professional associations, religious organizations). We denote the economy's institutions by the vector  $\underline{M}(t)$ . Thus  $\underline{M}(t)$  maps  $\underline{K}(t)$  into the set of economic futures, which we write as  $\{\underline{C}(s), \underline{K}(s), \underline{A}(s)\}_{s \geq t}$ . Thus, given  $\underline{K}(t)$  and given the institutions,  $\underline{M}(t)$ , the analyst should be able to make a forecast of the economy's future  $\{\underline{C}(s), \underline{K}(s), \underline{A}(s)\}_{s \geq t}$ .

An economy's sustainability index,  $W$ , is to be defined on the stock of its capital assets and institutions. That means we are to construct a  $W$ -function at  $t$

$$W(t) = W(\underline{K}(t), t), \quad (4)$$

that satisfies conditions (2).

Notice there are a number of capital assets that are both "means" (expression (4)) and "ends" (expression (3)). Health is a prime example. Good health is an end in itself ( $U$  would be directly dependent on it), but it also is a factor determining a person's productivity. Double counting should be encouraged if an asset offers double service. Similarly, some institutions are both "means" and "ends".

### **Shadow Prices**

Shadow prices relate the "means" to the "ends". For simplicity of notation, we take  $U$  to be the *numeraire*. Let  $q_j(t)$  denote the shadow price of consumption good  $j$  at time  $t$ . Then

$$q_j(t) = \partial U(\underline{C}(t), \underline{K}(t)) / \partial C_j(t). \quad (5)$$

Let  $r_k(t)$  be the shadow price of activity  $k$ . Then

$$r_k(t) = \partial U(\underline{C}(t), \underline{K}(t)) / \partial A_k(t). \quad (6)$$

(The shadow price of capital services that enter directly into  $U$  can be defined analogously.)

We assume without justification that  $V(t)$  is differentiable in  $K$ .<sup>2</sup> Differentiating  $V(t)$  with respect to  $t$  in (3) and using (2) yields the criterion for sustainable development at  $t$ :

$$dV(t)/dt = \partial V/\partial t + \sum[(\partial V(t)/\partial K_i(t))(dK_i(t)/dt)] \geq 0. \quad (7)$$

Define

$$p_i(t) = \partial V(t)/\partial K_i(t), \quad \text{for all } i. \quad (8)$$

$p_i(t)$  is the (spot) shadow price of the  $i^{\text{th}}$  asset at  $t$ . If  $i$  is a factor of production as well as a final consumption good (e.g., a wetland),  $p_i(t)$  reflects both. From expressions (1), (5), (6), and (7), we note that the shadow prices of consumption goods at all  $s$  (the  $q_j(s)$ s), as well as those of activity levels at all  $s$  are embodied in the shadow prices of capital assets at  $t$  (the  $p_i(t)$ s). In imperfect economies (e.g., those experiencing the tragedy of the commons) an asset's shadow price can be negative even when its market price is positive.

The definition of shadow prices tells us that three pieces of information are required for estimating them at  $t$ :

- (i) A dynamic model of the economy (the mapping  $M(t)$ ).
- (ii) The size and distribution of the economy's capital assets at  $t$ .
- (iii) A conception of intergenerational well-being ( $\bar{V}(t)$ ).

Requirements (i) and (ii) are the basis for estimating the changes that take place in the allocation of resources if an additional unit of the asset is made available free of charge. Requirement (iii) is the basis for placing a value on that change (definition (8)).

At any date an asset's shadow price is a function of the stocks of all assets. Moreover, the price today depends not only on the economy today, but on the entire future of the economy. So, for example, future scarcities of natural capital are reflected in current shadow prices of all goods and services. That means that shadow prices are functions of the degree to which various assets are substitutable for one another, not only at the date in question, but at subsequent dates as well. Of course, if the conception of intergenerational well-being involves the use of high discount rates on the well-being of future generations (i.e., if  $\delta$  is large), the influence on today's shadow prices of future scarcities would be attenuated. Intergenerational ethics plays an important role in the structure of shadow prices, a fact that was displayed in the contrasting recommendations of Cline (1992) and Stern (2006) on the one hand and Nordhaus (1994, 2008) on the other, over how much the world community should spend now to meet the problems of global climate change.

Equations (6)-(8) say that the ratios of shadow prices are marginal social rates of substitution between goods and services. In an economy where the government maximizes  $V(t)$ , marginal rates of substitution among goods and services equal their corresponding marginal rates

---

<sup>2</sup> For a justification see Dasgupta (2001: Appendix).

of transformation. As the latter are observable in market economies (e.g., border prices for traded goods in an open economy), shadow prices are frequently defined in terms of marginal rates of transformation among goods and services. However, marginal rates of substitution in imperfect economies do not necessarily equal the corresponding marginal rates of transformation. In our empirical application below, we use market prices as shadow prices for many goods and services, but estimate the shadow prices of a number of goods over whose production and distribution the market mechanism is known to be especially deficient.

### Comprehensive wealth

Imagine that we have estimated shadow prices on the basis of the information covering requirements (i)-(iii) above. In order to include in our accounting exogenous changes that the economy experiences (e.g., changes in total factor productivity), we take time also to be a capital asset. Let  $n(t)$  be the shadow price of time at  $t$ . So

$$n(t) = \partial V / \partial t. \quad (9)$$

We now use shadow prices as weights to construct an aggregate index of the economy's comprehensive stock of capital assets. Call that index, *comprehensive wealth*,  $W$ . Formally, we have

*Definition 1.* An economy's comprehensive wealth is the (shadow) value of all its capital assets and institutions, that is,

$$W(t) = n(t)t + \sum p_i(t)K_i(t). \quad (10)$$

We are interested in comprehensive wealth because of

*Proposition 1.* A small perturbation to an economy increases (resp., decreases) intergenerational well-being if, and only if, holding shadow prices constant, it increases (resp., decreases) comprehensive wealth.

Proof: Let  $\Delta$  denote a small perturbation. Then

$$\Delta V(t) = [\partial V / \partial t] \Delta t + \sum [\partial V / \partial K_i(t)] \Delta K_i(t). \quad (11)$$

As  $p_i(t) = \partial V(t) / \partial K_i(t)$  and  $r(t) = \partial V / \partial t$ , equation (11) can be written as

$$\Delta V(t) = n(t) \Delta t + \sum p_i(t) \Delta K_i(t). \text{ QED} \quad (12)$$

Now  $p_i(t) \Delta K_i(t)$  is the shadow net investment in asset  $i$ , and  $n(t)$  is the shadow price of time  $t$ . Write  $I_i(t) = p_i(t) \Delta K_i(t)$ . Then equation (12) can be expressed as

$$\Delta V(t) = n(t) \Delta t + \sum [I_i(t)].^3 \quad (13)$$

Definition 1 says that the expression on the right hand side of equation (13) is the *comprehensive investment* that accompanies the perturbation. This means Proposition 1 can be re-stated as

---

<sup>3</sup> It may seem odd to regard the first term in equation (13) as investment, since no one in the economy is doing anything other than wait to see the corresponding asset grow. However, as waiting is a cost, it seems to us entirely appropriate to include  $n(t) \Delta t$  in the conception of comprehensive investment.

*Proposition 2. A small perturbation to an economy increases (resp., decreases) intergenerational well-being at  $t$  if, and only if, the comprehensive investment at  $t$  that accompanies the perturbation is positive (resp. negative).<sup>4</sup>*

Comprehensive investment has a well-known welfare interpretation. Imagine that the vector of capital assets at  $t$  is not  $K(t)$  but  $K(t)+\Delta K(t)$ , where  $\Delta$  is an operator denoting a small difference. In the obvious notation,

$$V(K(t)+\Delta K(t)) - V(K(t)) \approx \int_t^{\infty} [\sum_j \Sigma(\partial \bar{U} / \partial C_j(s)) \Delta C_j(s) + \sum_i \Sigma(\partial U / \partial K_i(s)) \Delta K_i(s)] e^{-\delta(s-t)} ds. \quad (14)$$

Now suppose investment is increased at  $t$  for a brief moment  $\Delta t$ . We write the change in the vector of capital assets at  $t+\Delta t$  consequent upon the brief increase in investment as  $\Delta K(t)$ . So  $\Delta K(t)$  is the consequence of the increase in investment at  $t$ , and  $(K(t+\Delta t)+\Delta K(t))$  is the resulting vector of capital assets at  $t+\Delta t$ . Let  $\Delta t$  tend to zero. From equation (14) we obtain

*Proposition 3. Comprehensive investment measures the present discounted value of the changes in the consumption services that are brought about by it.<sup>5</sup>*

In studies on sustainable development (questions (B) and (C) we raised earlier) the perturbation is the passage of time itself, meaning that  $\Delta t > 0$ .

Notice that the relationship between intergenerational well-being and comprehensive wealth in Propositions 1 and 2 is an equivalence relation. The claim is that comprehensive wealth is an index of intergenerational well-being. The Propositions do not on their own determine whether comprehensive wealth in a particular economy can be maintained or whether vital forms of natural capital have been so depleted that it is not possible for the economy to enjoy sustainable development in the future. For example, it could be that an economy is incapable of achieving sustainable development indefinitely, owing to scarcity of resources or limited substitution possibilities among capital assets or because the scale of the economy is too large. To take another example, it could be that although the economy is in principle capable of realizing sustainable development,  $V(t)$  declines along the path that has been forecast because of bad government policies. For yet another example, consider an optimum economy, in which however  $\delta$  has been chosen to be so large that  $V(t)$  declines over time. The latter example demonstrates that "sustainability" and "optimality" are very different concepts. It can even be that along an optimum path  $V(t)$  declines for a period and then increases thereafter. As equation (13) shows,  $V(t)$  declines when comprehensive investment is negative.

But there is second kind of perturbation to an economy, involving a policy change

---

<sup>4</sup> There is no settled term yet for the linear index we are calling "comprehensive investment" here. I am borrowing the term from Arrow *et al.* (2009), but it has been called "genuine saving" (World Bank, 2006), and also "inclusive investment" (Dasgupta, 2007). I hope the term "comprehensive investment" will prevail, because it is vivid.

<sup>5</sup> Proposition 3 was implicit in Ramsey (1928), who studied a fully optimum development policy. Our formulation here shows that the proposition is very general.

(relevant for questions (D) and (E)), which we may call a *project*. A project is a perturbation to "business as usual" at a given moment in time,  $t$ , meaning that  $\Delta t = 0$ . In that case Proposition 1 can be interpreted as saying that a project should be undertaken if and only if the change in comprehensive wealth at  $t$  it gives rise to is positive. In view of Proposition 3 that is another way of saying that a project should be accepted if and only if the present discounted value (PDV) of the flow of social profits associated with it is positive.<sup>6</sup>

Proposition 1 explains why comprehensive wealth is the correct measure of intergenerational well-being and why it ought to replace GDP, NDP (see below), the United Nations Human Development Index (HDI), and the many other *ad hoc* measures that are listed in Table 1 and appear elsewhere for both sustainability and policy analyses. As wealth is a linear index of the stocks of the economy's (comprehensive) list of capital assets and institutions, while intergenerational well-being is a *non-linear* function of its determinants (as in various forms of Utilitarianism), it is a far more convenient index to use for responding to questions (B) to (E) than intergenerational well-being itself.

We could imagine that the typical perturbation considered in Propositions 1-2 involves positive investments in science and technology, and reproducible and human capital assets, but negative investments in natural capital assets (wetlands and forests). Proposition 2 says that so long as comprehensive investment is positive, intergenerational well-being increases. Note though that if vital forms of natural capital were to become very scarce, their shadow prices would be large, signalling that further declines in their amounts, even when small, would make a significant dent on comprehensive wealth.

---

<sup>6</sup> If the economy is following an optimum policy, no project would yield a positive PDV of social profits.



## References

Arrow, K.J., P. Dasgupta, L. Goulder, G. Daily, P.R. Ehrlich, G.M. Heal, S. Levin, K.-G. Maler, S. Schneider, D.A. Starrett, and B. Walker (2004), "Are We Consuming Too Much?", *Journal of Economic Perspectives*, 18(1), 147-172.

Arrow, K.J., P. Dasgupta, L.H. Goulder, K.J. Mumford, and K. Olseon (2009), "Sustainability and the Measurement of Wealth", Mimeo, Department of Economics, Stanford University.

Dasgupta, P. (2001), *Human Well-Being and the Natural Environment* (Oxford: Oxford University Press).

Dasgupta, P. (2007), *Economics: A Very Short Introduction* (Oxford: Oxford University Press).

Hamilton, K. and M. Clemens (1999), "Genuine Savings Rates in Developing Countries", *World Bank Economic Review*, 13(2), 333-56.

Parris, T.M. and R.W. Kates (2003), "Characterizing and Measuring Sustainable Development", *Annual Review of Environmental Resources*, 28, 559-586.

Pezzey, J. (1992), "Sustainable Development Concepts: An Economic Analysis," *World Bank Environment Paper* No. 2 (Washington DC: World Bank).

World Bank (2006), *Where is the Wealth of Nations?* (Washington, DC: World Bank).

World Commission on Environment and Development (1987), *Our Common Future* (New York: Oxford University Press).

## A Landscape Perspective on Sustainability Science

Monica G. Turner  
University of Wisconsin  
9 November 2009

Patterns of land use and land cover are key elements of social-ecological systems. Understanding the causes and consequences of alternative landscape patterns and, more generally, the functional importance of spatial and temporal heterogeneity should be a key component of sustainability science. This discussion paper (1) briefly summarizes insights from landscape ecology that may inform sustainability science and lead to new questions, and (2) suggests several potential research components and questions that should be included within sustainability science. The ideas offered here reflect a ‘land-change science’ perspective (Turner and Robbins 2008).

### Lessons from landscape ecology relevant for sustainability science

**The quantity and/or quality of many ecosystem services depend on heterogeneity at multiple scales of space and time.** As sustainability science moves forward, it is important that the consequences of spatial heterogeneity for ecosystem services be explicitly addressed. There are numerous examples in the literature. For example, landscape patterns affect the abundance of hosts and vectors that transmit Lyme disease (Allen et al. 2003); patterns of land use/land cover strongly influence hydrologic flow paths and delivery of nutrients to surface waters (Strayer et al. 2003) and can cascade to other trophic levels (Burcher et al. 2007); patterns of agricultural and natural/semi-natural habitats affect the diversity and abundance of natural enemies that prey upon agricultural pests (Werling and Gratton 2008); forest stand dynamics and connectivity influence infestation of bark beetles (Raffa et al. 2008). In addition to spatial heterogeneity on the ecological side, there is also tremendous heterogeneity among people, cultures and institutions that affects sustainability. *Questions: What aspects of spatio-temporal heterogeneity are critical to sustainability of socio-ecological systems? How are effects of spatial heterogeneity propagated through socio-ecological systems?*

**The quantity and/or quality of ecosystem services may be disproportionately affected by “keystone landscape elements.”** All patches and/or places are not equal with respect to their effects on state and dynamics of the system. With respect to either the provision of key ecosystem services (e.g., source-sink dynamics within a metapopulation) or locations that cause degradation of a service (e.g., few farms producing most of the P exported to a lake), patches are not equal with respect to their function. More broadly, this disproportionality probably applies to other components of complex adaptive systems, e.g., certain players or institutions will have greater influence on system dynamics than others, and understanding the key points of leverage is important. *Questions: How can the “keystone elements” of a social-ecological system be identified? Once identified, how can the behavior of “keystone elements” be changed?*

**Sustainability of local ecosystem services may depend on attributes of a much larger area.** Ecological studies have shown that ‘landscape context’ is important for a variety of responses. For example, pollinator diversity and fruit set in coffee plantations decline with distance of the coffee plantation from intact forest. Thus, conversion of forest in the broader landscape is

contributing to a local decline in pollination (Priess et al. 2007). Fires in boreal peatlands may be sources of atmospheric mercury that is then transported and deposited in northern lakes (Turetsky et al. 2006). Landscape context is also implicit in the “human footprint” that incorporates the extent of the landscape over which demand for goods and services extends.

*Questions: How are linkages that are distant in space (or time) incorporated within social-ecological systems? What is the balance between local dependencies and those contingent on broader surrounding areas?*

**Spatial thresholds of connectivity may lead to abrupt changes in processes.** Thresholds are inherent properties of both biophysical and social-ecological systems (e.g., Levin 1998, Groffman et al. 2005, Duit and Galaz 2008). Theory and empirical study have demonstrated the existence of spatial thresholds in abundance of a habitat or land-cover category at which connectivity suddenly changes (e.g., from well connected to disconnected). There is no magic value, however, because thresholds are scale dependent and specific for particular organisms or processes. However, small changes near the threshold can lead to large changes in a response variable. *Questions: What spatial thresholds in linked socio-ecological systems are likely to lead to undesirable changes? Can these be identified ahead of time?*

**The spatial heterogeneity created by humans is often qualitatively different from natural patterns.** Humans often re-scale spatial patterns, creating heterogeneity at broader scales while reducing heterogeneity at fine scales. For example, in agricultural areas, humans often impose coarse spatial patterns with sharp boundaries and greater contrast among land covers while homogenizing fine-scale variation in soil properties and biota. The sharp boundaries, high contrast, and altered functional connectivity resulting from human activity may change the quantity, quality and variability of ecosystem services and influence long-term sustainability. *Questions: How can human activities be organized such that they retain aspects of spatial heterogeneity that are fundamental to sustainability? What are the impediments to doing so?*

### Some needed components of a sustainability science

**Balancing tradeoffs.** There is no optimal land architecture that works for everything; rather, the composition and configuration of a landscape may be considered optimal for one set of responses but not for others. Thus, the kind, amount, distribution and patterning of land covers on the landscape is critical for evaluating tradeoffs. Understanding (a) that there are tradeoffs, and (b) the consequences of alternative landscapes for a variety of response variables (or ecosystem services) should be a key research goal in sustainability science (e.g., Naidoo et al. 2007, Carpenter et al. 2009). *Questions: Are there suites of services that all respond similarly or in opposite directions to anticipated changes? What methods are most effective for evaluating the tradeoffs among different scenarios? What are the implications for resilience and vulnerability of ecosystem services in different landscape patterns and change trajectories?*

**Complex interactions and unpredictable drivers.** Extrapolating future land-use patterns from past trajectories typically does not work, largely because of complex interactions among multiple drivers and radical changes in behavior that provide explanatory power in hindsight for observed changes but typically are not anticipated. Decisions that affect resource use, land management

and development trajectories are driven by multiple factors that may interact in ways that are not easy to discern. Further, there may be big, unpredictable changes in influential drivers, e.g., the onset of the environmental movement in the 1970s, the rapid decline of the Soviet Union, and the 1990s boom in the stock market had consequences for land use. Spatial heterogeneity also may interact non-linearly with other drivers to accelerate or dampen subsequent changes in ecosystem services (Peters et al. 2004, 2007). *Questions: How do suites of factors (both environmental and social) at multiple scales interact to produce different outcomes?*

**Incorporating dynamics into the sustainability framework.** Sustainability needs to be considered in the context of systems that are changing over time; a static endpoint or reference point is not likely to be workable. On the ecological side, concepts such as the “historic range of variability” attempt to capture the dynamics of a system over a long period of time such that excursions of the system beyond its historic bounds can be identified (Keane et al. 2009). *Questions: Is there a notion comparable to HRV that could work for sustainability science? In what ways can the dynamics of the system be incorporated? What range of dynamical behavior permits sustainability and/or resilience in a social-ecological system?*

**Vulnerability and risk given changing disturbance regimes.** The risk of catastrophe lies at the intersection of disturbance regimes and human land use. The consequences of changing disturbance regimes for the built environment are likely to be major issues over the short term (years to decades) as well as the long term (centuries or more). Increasing rates of change are clear for some disturbance regimes (e.g., the frequency of large fires is increasing in many areas worldwide) whereas others have greater uncertainty (e.g., whether hurricanes will increase in frequency or intensity is not resolved). However, there is a lot of development worldwide in areas that are vulnerable to natural disturbances. Special attention to events that are low probability but high impact is warranted. *Questions: How can vulnerability of social-ecological systems be reduced in the face of changing disturbance regimes?*

**Cognition, feedbacks and time lags.** The question of what perturbations or changes are perceived by people (cognition) and then elicit changes in their behavior that may re-direct the current trajectory of a system is an important component of sustainability science. Conditions may be either social or ecological. For example, there is a threshold of fuel prices that will cause behavioral changes, e.g., vehicle choices, patterns of residential development, commuting distances, willingness to increase energy-use efficiency, to support and use public transportation, etc. The cost of property insurance may cause people to avoid building or buying in locations vulnerable to natural disturbances. Events may also evoke a response. The 1993 floods along the Mississippi River caused some towns to move to higher ground, and a series of two 100-yr flood events within 10 months was enough to trigger movement of Gays Mills, Wisconsin, out of the floodplain. Anecdotal evidence suggests that Florida may be losing population, in part because of the sequence of four hurricanes that occurred in a single season. In contrast, changes that occur gradually may be less likely to elicit responses until change in the system becomes very obvious. In the absence of cognition, responses will not be activated (Comfort 2007). *Questions: What events or conditions elicit societal (or individual) responses, and do people respond in time to prevent undesirable or irreversible change?*

**Spatial legacies.** History matters for the current state of ecosystem services, and the influence of today's decisions and patterns imposed on our landscapes may extend far into the future. There are many examples documenting the importance of spatial legacies in ecosystems (e.g., Foster et al. 2003, Bennett et al. 2005, Fraterrigo et al. 2005), and this is probably true for social systems as well. *Questions: For how long and in what ways do today's land-use decisions constrain future patterns, processes and options?*

### Literature Cited

- Allan, B. F., F. Keesing and R. S. Ostfeld. 2003. Effect of forest fragmentation on Lyme disease risk. *Conservation Biology* 17:267-272.
- Bennett, E. M., S. R. Carpenter and M. K. Clayton. 2005. Soil phosphorus variability: scale-dependence in an urbanizing agricultural landscape. *Landscape Ecology* 20: 389-400.
- Burcher, C. L., H. M. Valett and E. F. Benfield. 2007. The land-cover cascade: relationships coupling land and water. *Ecology* 88:228-242.
- Carpenter SR, Mooney HA, Agard J, Capistrano D, DeFries R, Diaz S, Dietz T, Duriappah A, Oteng-Yeboah A, Pereira HM, Perrings C, Reid WV, Sarukhan J, Scholes RJ, Whyte A. 2009. Science for managing ecosystem services: Beyond the Millennium Ecosystem Assessment. *Proc Natl Acad Sci USA* 106: 1305-1312.
- Comfort, L. K. 2007. Crisis management in hindsight: cognition, communication, coordination and control. *Public Administration Review* 67 supp D.
- Duit, A. and V. Galaz. 2008. Governance and complexity—emerging issues for governance theory. *Governance: An International Journal of Policy, Administration and Institutions*. 21:311-335.
- Foster, D., F. Swanson, J. Aber, I. Burke, N. Brokaw, D. Tilman and A. Knapp. 2003. The importance of land-use legacies to ecology and conservation. *BioScience* 53:77-88.
- Groffman, P. M., J. S. Baron, T. Blett, A. J. Gold, I. Goodman, L. H. Gunderson, B. M. Levinson, M. A. Palmer, H. W. Paerl, G. D. Peterson, N. L. Poff, D. W. Rejeski, J. F. Reynolds, M. G. Turner, K. C. Weathers, and J.A. Wiens. 2006. Ecological thresholds: The key to successful environmental management or an important concept with no practical application? *Ecosystems* 9:1-13.
- Keane, R. E., P. F. Hessburg, P. B. Landres and F. J. Swanson. 2009. The use of historical range and variability (HRV) in landscape management. *Forest Ecology and Management* 258:1025-1037.
- Levin, S. A. 1998. Ecosystems and the biosphere as complex adaptive systems. *Ecosystems* 1:431-436.
- Musacchio, L. R. 2009. The scientific basis for the design of landscape sustainability: a conceptual framework for translational landscape research and practice of designed landscapes and the six Es of landscape sustainability. *Landscape Ecology* 24:993-1013.
- Naidoo R, Balmford A, Costanza R, Fisher B, Green RE, Lehner B, Malcolm TR, Ricketts TH (2008) Global mapping of ecosystem services and conservation priorities. *Proc Natl Acad Sci USA* 105: 9495-9500.
- Peters, D. P. C., B. T. Bestelmeyer and M. G. Turner. 2007. Cross-scale interactions and changing pattern-process relationships: consequences for system dynamics. *Ecosystems* 10:790-796.

- Peters, D. P. C., R. A. Pielke, Sr., B. T. Bestelmeyer, C. D. Allen, S. Munson-McGee, and K. M. Havstad. 2004. Cross scale interactions, nonlinearities, and forecasting catastrophic events. *Proceedings of the National Academy of Sciences* 101:15130-5.
- Priess, J. A., M. Mimler, A.-M. Klein, S. Schwarze, T. Tschardtke and I. Steffan-Dewenter. 2007. Linking deforestation scenarios to pollination services and economic returns in coffee agroforestry systems. *Ecological Applications* 17: 407-417.
- Raffa, K. F., B. H. Aukema, B. J. Bentz, A. L. Carroll, J. A. Hicke, M. G. Turner and W. H. Romme. 2008. Cross-scale drivers of natural disturbances prone to anthropogenic amplification: the dynamics of bark beetle eruptions. *BioScience* 58:501-517.
- Strayer, D. L., R. E. Beighley, L. C. Thompson, A. Brooks, C. Nilsson, et al. 2003. Effects of land cover on stream ecosystems: roles of empirical models and scaling issues. *Ecosystems* 6:407-23.
- Turetsky, M. R., J. W. Harden, H. R. Friedli, M. Flannigan, N. Payne, J. Crock and L. Radke. 2006. Wildfires threaten mercury stocks in northern soils. *Geophysical Research Letters* 33(16): L16403, DOI: 10.1029/2005GL025595.
- Turner, B. L., II, and P. Robbins. 2008. Land-change science and political ecology: similarities, differences and implications for sustainability science. *Annual Review of Environmental Resources* 33:295-316.
- Werling, B. P. and C. Gratton. 2008. Influence of field margins and landscape context on ground beetle diversity in Wisconsin (USA) potato fields. *Agriculture, Ecosystems and Environment* 128:104-108.

## **Complex adaptive systems and the challenge of sustainability**

**Simon Levin**

**Princeton University**

A central challenge facing society is achieving a sustainable future; on this point, there is broad consensus. But sustainability encompasses many dimensions, from financial markets to energy and natural resources, to biological and cultural diversity and ecosystem services; and there is much less consensus on how to balance among or within these elements. Societies are complex adaptive systems, composed of individual agents who have their own priorities, and who value the macroscopic features of their societies differently. Resolving those competing perspectives is at the core of addressing sustainability.

As other background papers develop, ecosystems provide a range of goods and services to humans that support the quality of our lives, and indeed life itself. The sustainability of those services is a prerequisite for the sustainability of life as we know it; hence we must determine how those services depend upon particular aspects of biodiversity, the dynamic mechanisms that sustain those aspects and make them robust to perturbation, and how measures of robustness translate across scales. Addressing these questions will require the marriage of empirical and theoretical work, and an understanding of complex systems that integrate processes operating at multiple scales of space, time and complexity. Mathematical models certainly will be central to this effort.

There is a long history of research into the management of fisheries and other natural resources, tracing back to the great mathematician, Vito Volterra, who developed dynamical systems approaches to understanding competitive interactions and the oscillatory nature of predator-prey interactions. Volterra's foundational work extends broadly to the dynamics of ecological communities; furthermore, it is central to the thinking of every ecologist, even those who cringe at the thought of formal mathematical explorations. It has stimulated mathematicians for a century to extend his results, though often with esoteric explorations that do little to inform ecological theory or management.

Fisheries science has a deep mathematical foundation, built not only on the work of Volterra and Alfred Lotka, but also on the remarkable contributions of Ricker, Beverton, Holt, and others. Yet despite this elegant body of theory, we have not sustained these resources. Marine fisheries are collapsing worldwide, and biodiversity is being lost. In part, this has resulted from the absence of a sufficient ecosystem perspective in fisheries management. Marine ecosystems, indeed all ecosystems, are complex systems, characterized by nonlinearities and the potential for sudden losses of robustness and subsequent regime shifts (Steele, 1998). Furthermore, just like societies, they fall into that special class of complex systems known as complex adaptive systems, integrating phenomena from individuals to whole systems, across scales. In such systems,

macroscopic patterns emerge, to large extent, from interactions at much lower scales of organization –individual agents, short time scales, and small spatial scales- and feed back to influence the dynamics at those microscopic scales.

There are striking regularities in the macroscopic features of ecosystems, which support the services on which society depends; and these regularities are key to the potential for ecosystems to sustain those services. Regularities extend from species-abundance relationships to species-area curves, from particle size spectra to trophic web topologies, from stoichiometric ratios to biogeochemical cycles. Although these patterns ultimately emerge from the multiplicity of microscopic interactions, their consistency implies that they are independent of many of the details of those interactions, or of the identities of the particular organisms that populate those ecosystems. This implies a need to relate phenomena across scales, from cells to organisms to collectives to ecosystems, and to ask how robust ecosystem properties are, in relation to the scale of observation; how robustness on one scale is related to properties at other scales; and how to manage these complex adaptive systems. We need a statistical mechanics of ecological communities, identifying macroscopic patterns across systems and across scales, and relating those patterns to microscopic dynamics.

The robustness of a system describes its capability to continue to function in the face of disturbance. There are, however, many paths to robustness, ultimately balancing rigidity or resistance with flexibility and resiliency. The influenza virus has been robust for millennia, despite the fact that individual strains are remarkably ephemeral: robustness at the collective level indeed emerges from the absence of robustness at the individual level. Similarly, experiments on biodiversity in grassland communities (Tilman (1996)) demonstrate that individual species may be highly variable, while aggregated measures of biodiversity show stability. This is reminiscent of the classical equilibrium theory of island communities (Simberloff 1974; MacArthur and Wilson 1967), demonstrating the constancy of species numbers in the face of high turnover in the identities of individual species.

Robustness is not necessarily a good thing, as we are reminded at the nadirs of economic downturns. When systems are in undesirable configurations, we want to overcome their robustness; when they are in desirable configurations, we want to maintain them. In either case, it helps to identify the features that make systems robust, and these involve the interplay among redundancy and degeneracy, heterogeneity and diversity, and modularity and compartmentalization (Levin 1999, Levin and Lubchenco 2007). Insufficient understanding of what it means for systems to be too interconnected has led to the current financial crisis (May et al, 2008); insufficient understanding of how changing properties of ecological systems in the face of climate change and species invasions similarly could endanger the robustness of our life-support systems. There are fundamental theoretical challenges in complex systems in understanding how the network of interactions propagates not only goods and information, but disturbances as well, and to learn from that how we might manage ecosystems to reduce the potential for collapse. Even more difficult is to achieve an understanding of how these networks of



interconnectivity self-organize, and whether there are characteristic topological configurations that serve as attractors.

One of the most famous of economic theories is Adam Smith's argument that collective well-being is best achieved by relying on the pursuit of individual self-interests, and that the "invisible hand" of the market would lead to maximal efficiency. Smith's discussion of these issues was deeply nuanced, but purist advocates nonetheless see in this theorem arguments against any government regulation of markets. However, we have seen the consequences of unregulated markets, and Smith himself would never have taken that extreme position- he was strongly opposed to monopolistic control, for example. Complex adaptive economic systems, driven by the self-interested behavior of individual agents, may well find equilibrium states; but there is no reason to believe that those states will achieve maximal social good. Similarly, ecosystems, as complex adaptive systems, may self-organize to relatively stable configurations, but there is no reason to assume that we will be happy with the outcomes.

These considerations lead to a number of scientific challenges in achieving sustainability in coupled natural and socio-economic systems,

- (1) Mechanistic understanding of ecosystem structure and organization, as well as of socioeconomic systems, will require new theories. These theories must merge holistic and reductionistic perspectives; must integrate physical sciences, social sciences and biological sciences; and must scale from the genomic and metagenomic to the biosphere, and from the individual agent to the dynamics of collectives at all levels.

Ecosystems and the biosphere are complex adaptive systems, in which changes in biotic composition and relationships among elements have consequences for system-level properties of interest. Loss of biodiversity has implications for climate change, but unless we can make the connections between the two we cannot determine what aspects of biodiversity are important for mitigating climate change. A hope is that because compositional changes often become apparent on much faster time scales than the more integrative system-level effects, they can serve as early-warning indicators of impending problems.

- (2) Ecosystem services are the ultimate integrators of microscopic processes; determining what services are appropriate management endpoints, what details of system organization support them, and what sustains the robustness of those features, is of essential importance. More generally, ecosystems provide diverse services to humanity, and those services are dependent upon biodiversity. A basic challenge is to elucidate the connections between biodiversity and ecosystem services.
- (3) What distinguishes complex adaptive systems from designed systems is that the macroscopic properties of those systems are emergent from lower-level interactions, rather than having been optimized according to performance criteria.

This makes it all the more challenging intellectually to explain apparent similarities in such properties across systems, from designed to self-organized, even when the levels of selection that have led to those patterns are vastly different. Fractal-like branching patterns occur in all systems, from snowflakes to bronchial trees to real trees and river basins, but the mechanisms that give rise to them are fundamentally different among these diverse examples. So too, it turns out, are the patterns when examined in detail.

The notion of system optimization dies hard, however. In ecology and the geosciences, the concept of Gaia as an optimized environment has grown to excess, despite protestations from population biologists and others, obscuring the valuable insights that a holistic approach can provide. More familiarly, lack of appreciation for what natural selection and self-organization can produce in the way of evolution of complexity has led to unjustified arguments for the notion of intelligent design. And in economics, Adam Smith's seminal notion of the invisible hand argues that in a free and open economy, those who pursue their own self-interests thereby benefit society as a whole; we have much evidence now that this is not necessarily the case.

To argue that these notions are simplistic does not imply that there is no value in examining whether and under what circumstances self-organized, complex adaptive systems may optimize system-level properties, at least subject to some constraints. But there is no logical reason why this should occur in general, and a fundamental theoretical question is to understand indeed how the system-level consequences vary in relation to the level at which selection occurs.

- (4) Complex systems have the potential for multiple stable states, system flips, path dependency and hysteresis. Recent approaches (Scheffer et.al 2009) explore methods for identifying indicators (like critical slowing down, or high variability) of impending transitions; this represents an extremely promising area for research. More generally, recognition of the nature of systems as operating on multiple time scales emphasizes the need to understand changes in slow variables that might destabilize systems.

Related research should emphasize how the topology of interconnections in a network influences robustness, and whether self-organizing systems tend towards greater robustness or towards the point of collapse, as in self-organized criticality.

- (5) Complex systems in general, and complex adaptive systems in particular, are characterized by the potential for contagious spread of information, goods, and disturbances. Classical approaches to modeling the spread of epidemics and forest fires may provide a starting point. Again, network theory can help characterize the interconnectedness of systems, and provide measures of system robustness and keys to robust management. What are the tradeoffs between modularity, redundancy and diversity?

- (6) Control engineers talk about systems as being “robust, yet fragile.” (Carlson and Doyle, 1999). This means that adaptation to particular sets of conditions trade off against the ability to respond to changing sets of conditions. There are fundamental tradeoffs, similarly, between vulnerability and adaptability in confronting uncertainty, and between exploration and exploitation. We have an inclination to suppress fluctuations in the systems we manage, from forests and oceans to financial systems; but fluctuations are how systems learn, and their suppression comes with a cost. Specific solutions to today’s problems may confer reduced capability to deal with tomorrow’s, so temporal discounting becomes a central issue. To deal with the challenges of the future, we need to develop adaptive approaches, based on learning from experience. We also need to learn how to aggregate individual discount rates, and achieve a common discount rate for society (Weitzmann, 2007)
- (7) Finally, and at the core of our environmental problems, is the fact that we live in a global commons, in which individual self-interests do not necessarily translate into the common good. We need to understand how cooperation emerges in simple systems, why cooperation breaks down as systems become larger, and how we can achieve cooperation at the global level in dealing with our common future.

## Bibliography

- Carlson, J. and J. Doyle. 2002. Complexity and robustness. PNAS 99:2538-2545.
- Levin, S.A. 1999. Fragile dominion: Complexity and the Commons: Perseus Publishing, Cambridge, MA, 250 pp
- Levin, S.A. and J. Lubchenco 2007. Resilience, robustness, and marine ecosystem-based management. BioScience 58:27–32
- MacArthur, R. H. and E.O.Wilson 1967. [The Theory of Island Biogeography](#) Princeton University Press. 102 pages.
- May, R.M., S.A. Levin and G. Sugihara. 2008. Ecology for bankers. Nature 451:893-895
- [Scheffer, M.](#) , [J. Bascompte](#), [W A Brock](#), [V Brovkin](#), [S.R Carpenter](#), [V.Dakos](#), [H.Held](#), [E.H van Nes](#), [M. Rietkerk](#) and [G. Sugihara](#) 2009 Early-warning signals for critical transitions. [Nature](#) 461:53-9

Simberloff, D. 1974. Equilibrium theory of island biogeography and ecology. *Annual Review of Ecology and Systematics*. 5:161-182

Steele, J.H. 1998. Regime shifts in marine ecosystems. *Ecological Applications*: Vol. 8, Suppl. 1: Ecosystem Management for Sustainable Marine Fisheries, pp. S33-S3

Tilman, D. 1996. Biodiversity: Population Versus Ecosystem Stability. *Ecology*: Vol. 77, No. 2, pp. 350-363.

Weitzman, M. 2001. Gamma Discounting. *American Economic Review*. 91: 261-271.

## **Measuring and Monitoring Progress Toward Sustainability<sup>1</sup>**

background paper for conference on  
**Towards a Science of Sustainability**

Steve Carpenter, Center for Limnology, University of Wisconsin-Madison  
srcarpen@wisc.edu

The natural world on which human life depends is changing rapidly. For the first time in our history as a species, we have clear evidence of our own role in transforming the planet, including profound changes to ecosystems and the services they provide to humanity. Drivers of environmental change are likely to intensify as human population grows and per-capita consumption expands. Adverse changes to the earth system and ecosystem services threaten human health, livelihoods and other aspects of our society. On the other hand, our awareness of these changes, expanding understanding of social-ecological systems and our capacity for action offer the hope of effective response. The challenge of sustainability is to grasp this opportunity and transform social-ecological systems to provide food, water, energy, health and human security in a manner that is economically, ecologically and socially viable for many generations.

The science, technology and policy communities offer a hopeful vision that favorable planetary conditions, ecosystem services, and human well-being can be achieved for the long run through certain approaches. Among these are institutional arrangements, technologies, policies, practices, investments in innovation and so forth. But how do we choose among the many options? Success and failure appear to be context-specific; no policy or practice is likely to solve all problems, in all places and times. At present, there are critical gaps in our knowledge of the social, biological, biogeochemical and physical foundations needed to make decisions for a sustainable future.

Sustainability of ecosystem services and human well-being is a long-term, spatially heterogeneous collection of experiments that require continuous innovation, evaluation and learning. We may not like to think of policies and practices as experiments in which long-term success entails some short-term failures. Nonetheless, this discomfort does not make the outcomes more certain, and does not diminish the need for careful assessment of, and appropriate response to, unexpected or unwanted outcomes. Those who are affected by policy choices will demand evidence for improvement in ecosystem services and human well-being. Thus policies and practices will have to be backed up by data and analysis that evaluate

---

<sup>1</sup>This paper is based closely on: Carpenter SR, Mooney HA, Agard J, Capistrano D, DeFries R, Diaz S, Dietz T, Duriappah A, Oteng-Yeboah A, Pereira HM, Perrings C, Reid WV, Sarukhan J, Scholes RJ, Whyte A. 2009. Science for managing ecosystem services: Beyond the Millennium Ecosystem Assessment. *Proceedings of the National Academy of Sciences* 106: 1305-1312.

conditions, trends and likely future trajectories of ecosystem services and human well-being. At present we lack the data, analyses, models and theories to meet this need.

**Toward a Science of Human-Environment Systems:** The fundamental need is to understand the dynamics of ecosystem services and human well-being as they interact from local to global scales in the context of multiple changing drivers. What combinations and quantities of ecosystem services can flow sustainably from a particular landscape? How do changing land use, nutrient mobilization, species composition and climate affect flows of ecosystem services? For a given landscape, what drivers can be managed, and how? What mixes of ecosystem services do people prefer? How do human choices and actions affect local flows of ecosystem services, and spill over to affect other regions? When do human actions aggregate to cause consequences for larger regions or the earth system? What institutions, incentives and regulations are effective in sustaining flows of ecosystem services? Such questions are a partial list, illustrative of the challenge before us.

Our ability to understand, anticipate and cope with the outcomes of complex human systems interacting with equally complex environmental systems is far deficient compared to the needs of policymakers for information. Yet there is tremendous potential to improve our ability to anticipate the effects of policy interventions on human actions, of human actions (e.g. greenhouse gas emissions, agriculture and forestry practices, nutrient mobilization etc.) on ecosystem services, and of ecosystem services on livelihoods, health, energy and food security.

The gaps in knowledge that exist today cannot be addressed through uncoordinated studies of individual components by isolated traditional disciplines. Instead, a new kind of interdisciplinary science is needed to build understanding of social-ecological systems. With respect to monitoring, measuring, and evaluating effects of policies and practices on ecosystem services and human well-being, there are at least two key needs which must co-evolve: place-based, comparative long-term theory-driven research, and the observation systems needed to support this research.

**Place-Based, Comparative, Long-Term, Theory-Driven Research:** Productive research on social-ecological systems must ground concepts and theories in real-world observations and analysis. There are long traditions of empirical field research in both natural and social sciences. Regardless of the disciplinary origins, successful projects share common features: (1) Study designs address specific research questions within an overarching conceptual framework; (2) Contrasts reveal key insights emerge from comparisons among places or regions, across spatial extents from local to global, and across periods of time; (3) Comparisons are guided by models that bridge observations to concepts and theories; (4) Consistent datasets are maintained using easily-repeatable methods. To understand changes and interactions of ecosystem services, contrasts across locales, scales and time periods are particularly important. To achieve this capacity, study designs must be coordinated among a network of places. This does not mean that each place implements the same design. It does mean that at each place the design allows for comparisons across the network of places, as well as opportunities for unique place-specific research. Such research must be guided by a conceptual framework that

can be applied at multiple scales and accounts for interactions across scales. Networked research also demands consistency in data collection across places and through time, as well as shared, transparent, interoperable capacity for information management, analysis, modeling and synthesis.

Existing management programs provide important opportunities to learn, but these are often missed. Conservation organizations, global institutions, and governments are increasingly engaged in projects intended to improve human well-being in concert with ecosystem services. In view of the current state of knowledge, such projects must be regarded as hopeful hypotheses to be tested, rather than guaranteed prescriptions for success. Yet only rarely is the success of these projects evaluated using appropriate data and indicators. Such projects should be designed to learn the factors that influence the outcomes of programs intended to improve ecosystem services and human well-being.

What must be added is a framework for assessing changes in social-ecological systems, using metrics and indicators that can be collected consistently and compared across the range of cases. The cost of implementing such a framework will be small compared to the cost of the projects themselves. The potential benefit is huge from assessing changes in ecosystem services and human well-being associated with conservation and development projects and then using that information to improve management. There are enormous gains to be had from adaptive design and implementation of projects for conservation, development and sustainability.

**Upgrade and Maintain Observation Systems:** The information needed to understand and manage human-environment systems is inadequate to the task, at every scale. Advances in basic science needed to meet sustainability goals are constrained by lack of data to evaluate concepts, theories and models. Furthermore, absence of observations of human and environmental systems undermines the ability of managers and the public to make appropriate responses to changing conditions and emerging threats.

Critical data needs include (1) comprehensive time-series information on changes in land cover and land use, biotic systems, and changes in use and ecological characteristics of oceans; (2) locations and rates of desertification; (3) spatial patterns and changes in freshwater quantity and quality, for both ground- and surface-waters; (4) stocks, flows and economic values of ecosystem services; (5) trends in human use of ecosystem services; (6) changes in institutions and governance arrangements; and (7) trends in components of human well-being (particularly those not traditionally measured, such as access to natural products that are not marketed). Observation systems should encompass both social and environmental phenomena, be sensitive enough to detect significant change, assess vulnerability and resilience, include multiple types of information (narrative, qualitative, quantitative data and historical records), and support decision-making as well as basic scientific understanding.

In addition to these core data sets, indicators are needed to bridge raw observations to scientific hypotheses or policy questions. Ideally, the set of indicators would be broad enough to address a range of sustainability issues, small enough to be manageable, and simple enough

to be applied consistently and affordably in different regions over long periods of time. Clear guidelines are needed for estimating and communicating uncertainties. The indicators should be relevant for projecting future changes in ecosystem services and human well-being. At present, we lack agreement on a set of indicators that meets these criteria and serves the needs of researchers and decision makers. The research and policy communities need to work together to design a set of appropriate indicators and implement the sustained monitoring programs that will be needed to ensure the availability of data and indicators for the long run.

**Imperatives:** We must establish a capacity to create and implement policies for social-ecological systems, predict consequences, and evaluate outcomes. Basic research on social-ecological systems must be expanded to build this capacity, and more appropriate, integrated approaches to research must be developed. This research must build on existing disciplinary strengths, bridge disciplines effectively, and create new areas of knowledge that are needed to build resilient social-ecological systems. Key results of this research must be applied effectively, and monitoring programs must be emplaced to evaluate outcomes. Such a massive effort in social-ecological science is unprecedented in human history, yet it is commensurate with current challenges and the potential of sustainability science.

## **References**

- Carpenter, S.R., R. DeFries, H.A. Mooney, S. Polasky, W. Reid and R. Scholes. 2006. Millennium Ecosystem Assessment: Research needs. *Science* 313: 257-258.
- Carpenter SR, Mooney HA, Agard J, Capistrano D, DeFries R, Diaz S, Dietz T, Duriappah A, Oteng-Yeboah A, Pereira HM, Perrings C, Reid WV, Sarukhan J, Scholes RJ, Whyte A. 2009. Science for managing ecosystem services: Beyond the Millennium Ecosystem Assessment. *Proceedings of the National Academy of Sciences* 106: 1305-1312.
- Cash, D.W., W.C. Clark, F. Alcock, N.M. Dickson, N. Eckley, D.H. Guston, J. Jager, and R.B. Mitchell. 2003. Knowledge systems for sustainable development. *Proceedings of the National Academy of Sciences* 100: 8086-8091.
- Clark, W.C., P.J. Crutzen and H.J. Schellnhuber. 2004. Science for global sustainability: toward a new paradigm. pp. 1-28 in Schellnhuber, H.J., P.J. Crutzen, W.C. Clark, M. Claussen and H. Held (eds.), *Earth System Analysis for Sustainability*. MIT Press, Cambridge, MA.
- Daily GC, Polasky S, Goldstein J, Kareiva PM, Goldstein LP, Ricketts TH, Salzman J, Shallenberger R. (2009) Ecosystem services in decision making: time to deliver. *Frontiers of Ecology and Environment* 7: 21-28.
- Folke, C. 2006. Resilience: the emergence of a perspective for social-ecological systems analysis. *Global Environmental Change* 16: 253-267.



ICSU (International Council of Science). 2009. Earth System Visioning: Developing a new vision and strategic framework for earth system research. <http://www.icsu-visioning.org/>

Levin, S.A. 1998. Ecosystems and the biosphere as complex adaptive systems. *Ecosystems* 1: 431-436.

M.A. (Millennium Ecosystem Assessment). 2005. *Ecosystems and Human Well-Being: Scenarios*. Island Press, Washington D.C. Available on the internet. <http://www.MAweb.org>.

Especially the following chapters:

4: State of the art in simulating future changes in ecosystem services

7: Drivers of change in ecosystem condition and services

9: Changes in ecosystem services and their drivers across the scenarios

13: Lessons learned for scenario analysis

Ostrom, E. 2007. A diagnostic approach for going beyond panaceas. *Proceedings of the National Academy of Sciences* 104: 15181-15187.

Parris, T.M. and R.W. Kates. 2003. Characterizing and measuring sustainable development. *Annual Review of Environment and Resources* 28: 559-586.

Parris, T.M. and R.W. Kates. 2003. Characterizing a sustainability transition: goals, targets, trends and driving forces. *Proceedings of the National Academy of Sciences* 100: 8068-8073.

Turner, B.L. II, R.E. Kasperson, P.A. Matson, J.J. McCarthy, R.W. Correll, L. Christensen, N. Eckley, J.X. Kasperson, A. Luers, M.L. Martello, C. Polsky, A. Pulsipher, and A. Schiller. 2003. A framework for vulnerability analysis in sustainability science. *Proceedings of the National Academy of Sciences* 100: 8074-8079.

Turner B.L. II, Lambin E.F., Reenberg A. 2007. The emergence of land change science for global environmental change and sustainability. *Proceedings of the National Academy of Sciences* 104: 20666-20671.

## **Measuring and Monitoring Progress Toward Sustainability**

**V Ramanathan  
Scripps Institution of Oceanography  
University of California at San Diego  
La Jolla, CA 92093**

**First Version submitted November 13, 2009**

**Modified on Jan 07, 2010**

**Background Paper for the NSF workshop on  
Sustainable Development and Sustainability Science  
November 30 to Dec 2, 2009**

## PREAMBLE

*What are we trying to sustain?* This article supposes that human well-being, the natural ecosystem and the atmosphere that surrounds the ecosystem should be sustained.

*How do we monitor progress towards sustainability?* The answer to this question is straight-forward, for very little- if not zero- progress has been made towards sustaining either the eco- system or the atmosphere that surrounds it. This statement can be challenged by pointing out how we averted the stratospheric ozone-hole disaster with the Montreal protocol, etc. But the impending climate change beyond 2<sup>0</sup>C during the twenty first century is likely to dwarf the unprecedented accomplishment in preserving the life-sustaining ozone layer.

## I. SETTING THE STAGE

I will start with the following questions:

*How do we monitor the current unsustainable path?*

*How do we unravel the fundamental drivers for this unsustainable path?*

Let us start with an overly simplistic schematic of how humans interact with the environment and the earth system (Figure 1).

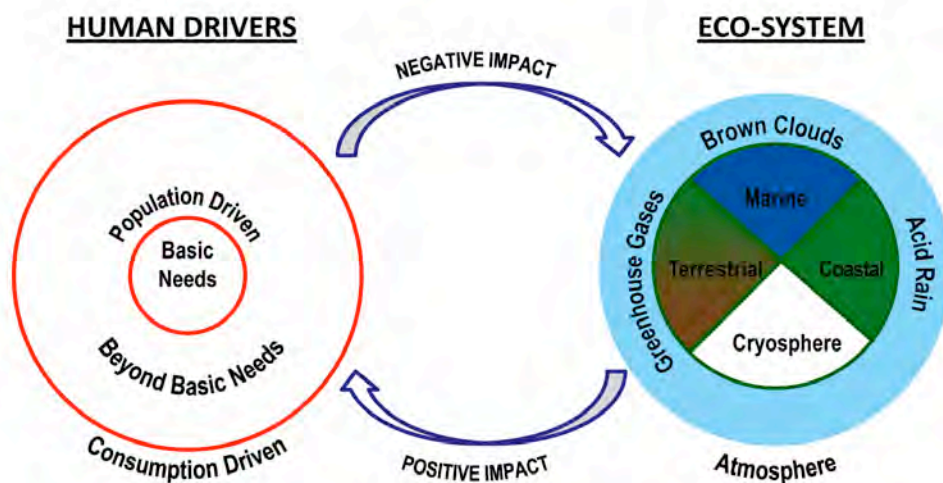

Homo sapiens began as an integral part of the eco-system, i.e., as an internal component. In other words, homo sapiens and the eco-system constituted a closed system, with the incoming solar energy as the sole external driver. Some time during the last millennia, humans evolved into an external driver, leaving behind enormous unrecyclable waste

either in the atmosphere or in the land-ocean-cryosphere system. The atmosphere alone holds about 1000 billion tons of manmade CO<sub>2</sub>, wide spread brown clouds of toxic SO<sub>2</sub>, CO, NO<sub>x</sub>, Ozone, black carbon, hundreds of organic compounds and acids, depleted ozone layer, etc. Similar waste and destruction of the eco-system have been chronicled elsewhere and need no repetition here (e.g see Schellnhuber, Crutzen, Clark et al, Dahlem Conf Book, 2003).

### *Where do we start the monitoring?*

With advanced instrument technology and observing platforms such as aircraft, ships, satellites and autonomous systems such as UAVs, we have made impressive advances in documenting human induced changes on the chemical and physical state of the ecosystem and the atmosphere. We are just beginning to scratch the surface with respect to the biological state. I will assume these advances will continue with continued federal and private support, and begin first with the major gap in advancing the goals of sustainability science.

We have very limited and grossly inadequate quantitative understanding of the human drivers of the unsustainable changes that we are witnessing currently. For example, most if not all of the IPCC-climate models, by pass the whole human-drivers and instead prescribe the changes in surface emissions of pollutant gases. As a result these models have no predictive capability and their simulations of future climate changes are simply projections based on assumed growth rates in emissions of pollutants such as CO<sub>2</sub>.

**Start with Human Drivers of Change:** Referring back to Figure 1, there are two basic human drivers of change. The first driver is the eco-system services needed to meet the basic human needs that must include: Food, water, shelter, health, education and recreation. The eco-system stress resulting from meeting the basic needs, assuming there is a common denominator for all nationalities and ethnic groups, is basically determined by population. All other activities that fall outside, which for lack of a better term, we will refer to as ‘beyond basic needs’. This category must include development that are critical for evolution of human species (e.g. information technology; space exploration), luxury items and leisure activities that fall under wealth acquisition. These are driven more by consumption than population growth. Relevant example is the current conflict and rancorous exchange between developing and developed nations about who is responsible for global warming. The developing nations point out that about 70% of the CO<sub>2</sub> in the atmosphere was dumped by about 30% of the global population in developed nations. The categorization of all human drivers into two developmental areas is an overly simplistic way of describing an incredibly complex pattern of human intervention(e.g. see background papers by Clark; Das Gupta and Levin . But the approach taken here does not depend on the number of categories.

The monitoring system has to be designed by social scientists. It may also have to include neuro-scientists to fully understand the unsustainable nature of resource consumption by humans in spite of overwhelming evidence of disastrous outcomes. Obviously such a

system must take into account the interactions between human behavior, technology, energy, economy and the environment. I don't mean to imply we have to start from a vacuum. There are tremendous amount of socio-economic data but these are in heterogeneous formats and not all of it are digitized. The first task is to digitize these in a common data format and make it available with a data management system akin to EOSDIS developed by NASA.

**Access Market Research Data on Consumption:** Market research done by commercial institutions must contain vast amounts of data on patterns of human behavior, dependency on material goods, and consumption patterns as well as socio-economic data. These data sets must have been collected with billions of dollars of investment and we must look into accessing this data as part of the sustainability science data integration system (SSDIS). It is also likely these commercial research centers can be co-opted to advance the causes of sustainability science.

**Monitor Response of Technology to Climate Change Regulations:** Local, national, regional and global mitigation actions and regulatory policies would soon (by 2020) become the norm. The next few decades will offer unique insights into how technology responds and evolves into sustainable pathways. Technology is assumed to contribute immensely to human well being (Fig 2a); but because of its negative impacts on air, water and other parts of the ecosystem, it is unclear to what extent its positive impact on individual basic needs is offset by its regional and global impact on the environment (Fig 2b). Sustainability science should exploit technology and guide it to Advance the goals of sustainable development (Fig. 2C). For example, the field can develop integrated models to evaluate the impact of new technologies (on human well being and environment) before they are made available to society. Had such a model evaluation been conducted for corn ethanol (including its impact on water, greenhouse

gases and food prices), it is likely this technology would have been shelved.

#### A. SOCIETY-TECHNOLOGY INTERACTION: DESIRED OUTCOME



#### B. CURRENT STATUS



#### C. PATH TO THE DESIRED OUTCOME: SUSTAINABILITY SCIENCE

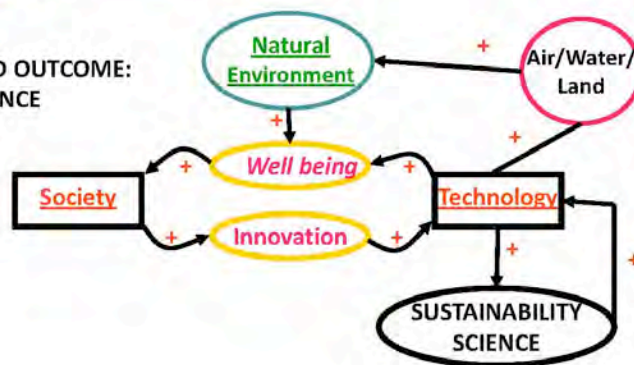

## II. A HISTORIC AND UNIQUE OPPORTUNITY FOR MONITORING SOCIETY'S RESPONSE TO UNSUSTAINABLE DEVELOPMENT

**Changes to the physical climate system:** We have already added enough greenhouse gases (CO<sub>2</sub>, CH<sub>4</sub>, N<sub>2</sub>O, HFCs, HCFCs, Ozone) and black carbon (soot) to warm the climate system by more than 2<sup>0</sup>C. At the current rate of addition of greenhouse gases, this

committed warming can increase to 3<sup>0</sup>C. About half of this warming is masked by the

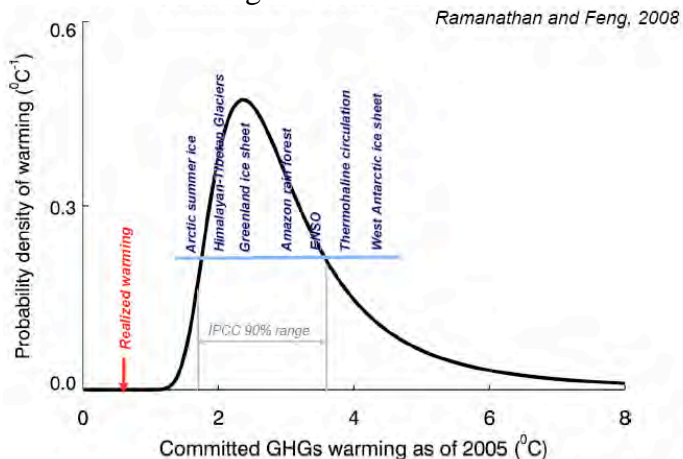

dimming due to manmade aerosols (sulfates, nitrates etc) and another 20% is stored in the oceans to be released in the coming decades (IPCC, 2007; Ramanathan and Feng, PNAS, 2008). As this warming unfolds during the next 25 to 50 years, we will witness iconic changes to several climate elements and eco-systems around the world (Figure 3).

***Changes in Human Drivers:*** The COP\_15 meeting in Copenhagen and follow-on activities should lead to major mitigation actions. Already we see movements in both developed and developing nations to tap into renewable energy resources, improve energy efficiency among other changes. But should these actions fail to slow down the warming, demands for geo-engineering will grow exponentially. Thus the planet will witness major changes in human behavior and hopefully there will be a rapid turn towards sustainable pathways for energy consumption.

***We must have a Monitoring System in Place:*** In addition to assembling the data on human drivers, we must improve our monitoring of the ecosystem, both the natural and the managed system. Current monitoring platforms are adequate (if maintained) to monitor large scale and global scale changes. But the needs of the society are at local scales that are relevant for decision making, and here our monitoring system needs major additions, both with in-situ and space based systems.

### III. FIELD EXPERIMENTS TO ADVANCE SUSTAINABILITY SCIENCE

Atmospheric scientists and ecologists have made major progress in unraveling the human impacts on environment and climate by conducting large field campaigns with aircraft, ships and surface observatories. Similar approach is required in sustainability science to test and advance various concepts that have been advanced during the last few decades (e.g see articles by Clark and Das Gupta in this series). However, sustainability science requires a major departure from the field experiments conducted by natural scientists. These natural science field experiments are mostly passive experiments in which we observe the atmosphere or eco-system as is and integrate these with conceptual or numerical models to infer the connections and feedbacks between the change in

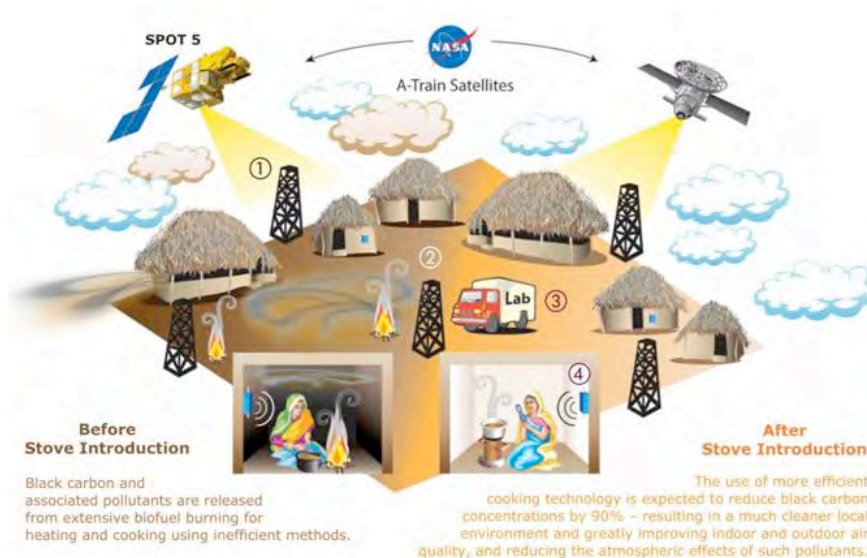

emissions of pollutants and the response (of climate/weather/eco-system, etc). In sustainability science we are trying to advance our understanding of the interactions between the human drivers and the environment including climate and eco-system. In my opinion, progress can be accelerated if

we embark on active scientific-intervention experiments. An example of such a project that is currently under-way *Source: Ramanathan and Thomas, 2009.*

is given below.

**PROJECT SURYA ([HTTP://WWW.PROJECTSURYA.ORG/](http://www.projectsurya.org/)):** About 3 billion live with out access to fossil fuels. This rural population meet their cooking and heating needs by burning biomass fuels. Steering this large population towards sustainable pathways of energy use would be a major step towards sustainable development. Among the many obvious reasons, the following are noteworthy: The indoor and outdoor exposure to soot, CO and other pollutants leads to over 2 million deaths annually in Asia alone. The smoke also reduces air quality outdoors. The emission of black carbon in soot and its subsequent absorption of solar radiation is now emerging as a major contributor to regional climate changes (monsoon; Hindu Kush Himalayan glaciers). Finally, black carbon emissions from burning of fossil fuels and biomass fuels is a large contributor (about 20% to 50% of the CO<sub>2</sub> greenhouse effect) to global warming.

Project Surya has proposed to provide cleaner cooking technologies ( biomass burning stoves with reduced soot emissions; bio gas plants; solar cookers) and electricity (bulbs that use PVs) for one rural area (in the Gangetic plains of N India) with about 5000-10000 households. This area will be monitored with sophisticated sensors (on cell phones; towers; inside home monitors) and with ultra-high resolution satellite data (launched by commercial ventures for GPS and communication purposes). Baseline data will be collected for 1 year prior to intervention and followed 1 year after intervention to assess the impact of newer technologies on: human exposure; air quality; reduction in global warming potential by black carbon. Satellite data should document the black carbon/smoke-hole created by the intervention. The field experiment, if expanded to accommodate the needs of sustainability science, should give us much needed insights



into why and how society adapts and uses new technologies; and how to steer the roughly 40% of the world population towards sustainable development.

Acknowledgment: This work was funded by the National Science Foundation –ATM grant to the author. Prepared with significant input from Girija Ramanathan. The author holds the copyrights for this paper, which is posted in <http://www-ramanathan.ucsd.edu/>.

## **Managing Human-Environmental Systems for Sustainability**

**Arun Agrawal**

**Background note prepared for, “Towards a Science of Sustainability” conference,  
Nov. 30-Dec. 2, 2009, Warrenton VA**

### **Introduction**

To manage human-environmental systems for sustainability is in substantial measure to manage for sustainability. The enormous body of work on sustainability highlights on the one hand the difficulties of defining it, but also the necessity of achieving it. Many papers on sustainability juxtapose the multiple dimensions along which one can (or must) think about sustainability (ecological, social, technical, economic, financial) at the same time as the tensions across these different dimensions make their simultaneous enhancement difficult if not impossible. And although sustainability of human-environmental systems requires by definition that management seek to improve outcomes jointly -- in at least two dimensions, most empirical work on managing sustainability fails even in terms of having the data that can provide information about outcomes in multiple dimensions.

To write about managing for sustainability is to confront simultaneously two critically contested concepts: management and sustainability. Like an elephant in a room, sustainability in a sentence tends to draw attention mainly to itself. Working against that tendency – to focus on sustainability in writings on sustainability – this paper tries instead to develop a common-sense argument about the multiple meanings and instruments of management as a way to approach somewhat obliquely the idea of managing for sustainability. It also attempts to identify strategies to achieve desired outcomes that exceed the commonsensical meanings of management, and which are likely necessary for sustainability in many situations. After all, it is not just management that leads to sustainable human-environmental systems.

An observation on style and context – In light of time and length limitations as also my understanding of the purposes of this exercise, this note focuses less on complete or careful arguments, more on potentially provocative generalizations. To this end, much of it is organized as a series of propositions. Because my principal area of work is common pool resource systems, the study of commons constitutes the empirical context for many of the propositions that follow.

### **Management**

The note distinguishes among three different, historically sedimented meanings of management: to shape outcomes or processes by directing and controlling, to affect them through better knowledge and calculations based on better knowledge; and to influence them by caring and cultivating. These three ways of thinking about management derive from different social grounds – that related to rule and discipline; business and economy; and gardening and community.

The idea of management-as-control is based on the exercise of authoritative, even authoritarian, power and rests on the belief that it is possible to reshape people and nature – thus, both parts of human-environmental systems – in desired directions and for desired goals by force. Some basic knowledge of such systems is assumed of course, but it is force and power that is valorized, not the detailed knowledge of that which is to be managed.

More popular views of management identify it with the process of achieving a set of goals by efficiently using available physical, financial, and human resources. Planning for outcomes, executing the plans, and measuring results (so as to make appropriate modifications to plans) are key elements of managerial efforts that rest on calculation. Management-through-calculation is all about improvements in knowledge, and the use of improved knowledge of human and environmental processes to identify and change the key factors that influence outcomes.

Management-as-care/cultivation is about encouraging the natural development and unfolding of objects and beings that are to be managed. The metaphors of cultivation and caring, when applied to management, are analogous to what a guardian or a steward does when helping in the achievement and enhancement of the existing potential of that which is being managed. Instead of forceful application of power, or strategic application of knowledge to change managed system(s), the manager identifies with the natural rhythms of such systems and helps them realize their latent possibilities.

These three ways of managing are correlated with specific forms of power: force, knowledge, and empathy. They are also associated with specific ways of exercising power: discipline, government, care. One can perhaps even identify specific historical periods in which these specific managerial strategies and the forms of power on which they are based become more prominent. In practice managerial practice, of course, these analytically distinct management forms and strategies of power are often combined by managers.

### **Propositions**

Writings on management for sustainability tend to be driven by and find their orienting compass in the second meaning of management – the generation of better knowledge about

factors, processes, and relationships that constitute human-environmental systems and the use of this knowledge to identify and apply resources at appropriate points to leverage improvements in outcomes.

The propositions in this section are grouped into two sets. The first set of propositions uses a simple abstract depiction of a coupled human-environmental system to focus on the knowledge gaps that hobble management of sustainability were a management-through-knowledge view sufficient to accomplish effective management. The second set of propositions points to the limits of a management-through-knowledge perspective.

### Knowledge gaps that undermine management through better knowledge

Consider the following abstract depiction of a simple two-level human-environmental system where the environmental part of the coupled system is a forest common.

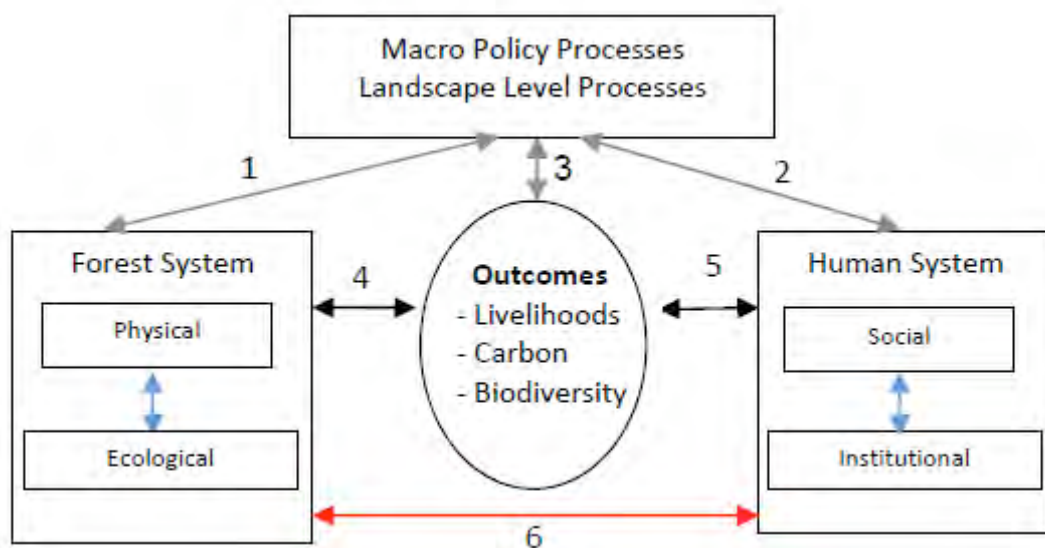

Figure 1:

The box at the top, representing landscape and macro-policy relationships forms the context within which forest commons systems are situated. The two lower boxes in the figure represent a forest system and a human system, and together with the arrows that connect them, these boxes constitute the forest commons system. The central oval represents a set of three outcomes – two pertaining to the forest system (carbon and diversity) and a third – livelihoods – that pertains to the human system. The arrows in general indicate that causal influences are likely to be bidirectional over time, even if at any given point in time it might seem logical and convenient to represent them as running in only one direction.

Few existing studies of human-environmental systems examine the relationships depicted in the figure across scales (grey arrows, 1-3) or across these coupled systems (red arrow, 6). Nor does existing work on human-environmental systems analyze the simultaneous and distinct generation of the joint outcomes that coupled systems always produce as a result of the interactions between the human and environmental system. Typically, the complexity of the interactions in human-environmental systems has been studied in the existing literature within the human or the environmental systems (blue arrows) or between the human or environmental systems and the outcomes that pertain to that system (represented in the figure as black arrows 4-5). These observations lead to the following propositions as regards the knowledge gaps that need to be filled if management-through-calculation is to occur effectively in human-environmental systems

1. Human actions and interventions are only a part (small to large) of the processes that influence the behavior of human environmental systems. Ecological and physical processes, similarly, also constitute only a part of the dynamics of such systems. Yet, there is substantial resistance in the practice of finer-scale models and empirical work against integration of both sets of processes. Further, although calculative management requires data and parameters for relationships that join human and environmental systems, little existing management or scholarship possesses the knowledge necessary to analyze the joint outcomes of coupled human and environmental systems. Therefore, management diagnoses and prescriptions based on analyses of either human or environmental systems that are in reality coupled carry substantial risks of exacerbating the iatrogenic effects of management (Illich, McKnight, Bavington).
2. Theoretical models of coupled human and environmental systems are heroic abstractions; experimental evidence on the behavior of such systems is difficult to generalize. This is because actually existing examples of human-environmental systems are shaped by the operation and interactions of a far larger number of critical factors and processes than is typical of models, and that simultaneously occupy a wider range than is typical of experimental studies. Deeper understanding of such systems requires far better understanding of relevant interactions, their measurement, and monitoring of outcomes than is currently available, particularly when it comes to the simultaneous consideration and integration of data, methods, and theories of the human and the environmental.
3. Effective management depends at least partly on scale and complexity. With increasing number of agents, relationships, and interactions along possible relationships, the capacity to manage declines exponentially.

Is management-based-on-knowledge sufficient for human and environmental system sustainability?

Although the three propositions above concern the knowledge needed to undertake management through calculation, having such knowledge is likely still inadequate for management of human and environmental systems sustainably. Three additional propositions elaborate on this idea.

1. Management has a specific meaning (better management through knowledge and calculation) when used by scientists, in practice a very large number of human actions constitute management interventions. A view of management that focuses on improved knowledge as critical for better management means that interventions to change system outcomes are likely to occur after windows of opportunities to intervene have closed. This is particularly true of complex systems characterized by processes that have feedback, long time-lags and non-linear relationships.
2. Law/regulations, knowledge-based incentives, and care are all necessary to change outcomes in human and environmental systems. A focus on management-as-knowledge constrains and truncates the range of options available to manage.
3. Although education about some kinds of human and natural systems has created or found channels through which those trained as managers can manage these systems, knowledge and education about human and environmental systems is far more distanced from the organizations charged with managing such coupled systems.

### **Conclusions**

When Clark and Dickson (2003) contrast “sustainability science” with the “science(s) of sustainability, they do so to highlight the extent to which uncertainty and fuzziness continue to mark existing knowledge about what leads to sustainability. In addition to drawing out some of the ways in which management of human and environmental systems is hobbled by continuing lack of knowledge about how such systems interact and with what effect, this note has also sought to draw attention to forms of management for sustainability that rest on other means to achieve outcomes than better knowledge.

**Managing Human-Environmental Systems for Sustainability:  
The Ultimate Systems Problem**

**T.E. Graedel**, Yale University, USA

(This background paper is based on the introductory chapter of  
*Linkages of Sustainability*, T.E. Graedel and E. van der Voet, Eds.,  
MIT Press, 2010.)

**THE COMPONENTS OF SUSTAINABILITY**

Most of the topics that relate to sustainability have been addressed in detail, if in isolation, by the scholarly community. The human appropriation of Earth's supply of fresh water, for example, has been discussed by Postel et al. (1996). Similarly, the limits to energy, and the ways in which energy in the future may be supplied, is the subject of a five-year effort led by Nakićenović et al. (1998). Mineral resources are treated, again in isolation, by Tilton (2003). Other research could be cited, but the central message is that the investigations in one topical area related to human interactions with environmental and planetary systems do not generally take into account the limitations posed by interacting areas of study. Engineers like to talk of their profession as one that is centered on "designing under constraint," and optimizing a design while recognizing a suite of simultaneous limitations. For the Earth system, including but not limited to its human aspects, the constraints are numerous and varied, but it is still the integrated behavior that we wish to optimize, not selected individual components, in moving toward sustainability.

A challenge in addressing some of these questions in detail involves not only the flows of resources into and from use, but also information on stocks, rates, and tradeoffs. The available data are not consistent: the stocks of some of Earth's resources, those yet untapped and those currently employed, are rather well established, while for others there remains a level of uncertainty that is often substantial. In the ideal situation, the resource levels would be known, their changes monitored, and the approaches to the limits of the resource could then be quantified. Consider Fig. 1a, which could apply, for example, to a seven-day space flight. The stock is known, the use rate is known, the future use can be estimated, and the end of the flight established. So long as total projected use does not exceed the stock, adequate sustainability is maintained.

Consider now Fig. 1b, the "Spaceship Earth" version of the diagram. Here the stock is not so well quantified. The general magnitude is known, certainly, but the exact amount is a complex function of economics, technology, and policy – consider oil supply and its variation with price, new extraction technologies, and environmental constraints. This means that stock is no longer a fixed value, but that its amount may have the potential to be altered. Rates of use can be altered as well, as demonstrated so graphically in the scenarios of the Intergovernmental Panel on Climate Change (2008) for future climate change, not to mention changes in commuter transportation with changes in fuel prices. Nonetheless, the starting point for consideration remains the same: How well can we quantify the factors that form the foundation for any consideration about the sustainability over time of Earth's resources?

A major complicating factor in this assessment is that Earth's resources cannot be considered one at a time; there are interdependencies and potential conflicts. A textbook example is water, an essential resource for human life and for nature. We use water for drinking, working, and cooking, but water is also needed to produce food and to enable industrial processes. More water could be supplied by desalinizing ocean water, but that process is very energy-intensive. Is our energy supply



adequate in the face of such a major new use? The problem thus becomes one of multi-parameter optimization, of deciding what is possible. This cannot be achieved without doing the best job we can of putting numbers and ranges on key individual resources related to sustainability, and doing so from a systems perspective.

## **THE CHALLENGE OF SYSTEMS**

Understanding how best to *move along the road toward sustainability*, as contrasted with *understanding the levels and types of unsustainability*, is an issue that has not yet been addressed in detail. The former is centered in environmentally-related technology, the latter on environmentally-related science, yet each can be properly treated only by addressing both closely and distantly related disciplines. Sustainability thus becomes a systems problem, one that defies typical piecemeal approaches such as: Will there be enough ore in the ground for technological needs? Will there be enough water for human needs? How can we preserve biodiversity? Can global agriculture be made sustainable? These are all important questions, but they do not deal with comprehensive systems issues, and do not provide a clear overarching path for moving forward, partly because many of these issues are strongly linked to each other.

It may help to picture the challenge of sustainability as shown in Figure 2, where the physical necessities of sustainability are shown as squares and the needs as ovals. It is clear that a near-complete linkage exists among all of the necessities and all the needs, yet tradition and specialization encourage a focus on a selected oval and all the squares, or a selected square and all the ovals. Can we devise an approach that deals with them all as a system, providing the basis for constructing a coherent package of actions that optimize the system, not the system's parts?

## MULTILEVEL SYSTEMS

Systems biology operated at a number of spatial levels, as suggested by the left side of Figure 3 (see also Levin, 1992). For technological systems, perhaps exemplified by the automotive system in the center of Figure 3, the challenges are not so much understanding the components, but appreciating the systemic and multilevel nature of the technology-society interaction. Even a cursory evaluation of the automotive system indicates that attention is being focused on the wrong target, and illustrates the fundamental truth that a strictly technological solution is unlikely to fully mitigate a culturally-influenced problem. The engineering improvements of the vehicle - its energy use, its emissions, its recyclability, and so forth, on which much attention has been lavished - are truly spectacular. Nonetheless, and contrary to the usual understanding, the greatest attention so far as the system is concerned should probably be directed to the highest levels - the infrastructure technologies and the social structure. Consider the energy and environmental impacts that result from just two of the major system components required by the use of automobiles. The construction and maintenance of the "built" infrastructure - the roads and highways, the bridges and tunnels, the garages and parking lots - involve huge environmental impacts. The energy required to build and maintain that infrastructure, the natural areas that are perturbed or destroyed in the process, the amount of materials demanded, from aggregate to fill to asphalt - all are required by the automobile culture, and attributable to it. In addition, a primary customer for the petroleum sector and its refining, blending, and distribution components - and, therefore, causative agent for much of its environmental impacts - is the automobile. Efforts are being made by a few leading infrastructure and energy production firms to reduce their environmental impacts, but these technological and management advances, desirable as they are, cannot in themselves begin to compensate for the increased demand generated by the cultural patterns of automobile use that has been stimulated by the geographical patterns of urban sprawl.

## THE UTILITY OF AN INTEGRATED UNDERSTANDING

Can modern technology feed the world of nine billion people or thereabouts in 2050? Yes it can, if the agricultural sector is provided with sufficient land, energy, water, advanced-technology equipment and a suitable regulatory structure. Can sufficient energy be supplied to serve the needs of nine billion people or thereabouts in 2050? Yes it can, if the energy sector is provided with sufficient land, water, advanced-technology equipment and a suitable regulatory structure. Can sufficient water be supplied to serve the needs of nine billion people or thereabouts in 2050? Yes it can, if the water sector is provided with sufficient energy and advanced-technology equipment. Can the non-renewable resource sector supply the materials needed by the advanced technology sector in meeting the needs of nine billion people or thereabouts in 2050? Yes it can, if the sector is provided with sufficient land access, energy, water, and a suitable regulatory structure. Can these important, overlapping needs be addressed in a quantitative, systemic way so as to move the planet in the direction of long-term sustainability? To put it another way, can we address the right side of Figure 3 as a systems problem that involves technology, society, and the environment, crossing the lines between the disciplines, as well as the spatial levels that challenge the thinking of those disciplines? And, from the perspective of this workshop, can we stimulate the research activities of those who may be able to address this ultimate systems problem in ways that can ultimately propel humanity toward a more sustainable future?

## References

Levin, S.A., The problem of pattern and scale in ecology, *Ecology*, 73, 1943-1967, 1992.

Intergovernmental Panel on Climate Change, *Climate Change 2007, The Fourth Assessment Report*, Cambridge, UK: Cambridge University Press, 2008.

Nakićenović, N., A. Grübler, and A. McDonald, *Global Energy Perspectives*, Cambridge, UK: Cambridge University Press, 1998.

Postel, S.L., G.C. Daily, and P.R. Ehrlich, Human appropriation of renewable fresh water, *Science*, 271, 785-788, 1996.

Tilton, J.E., *On Borrowed Time? Assessing the Threat of Mineral Depletion*, Washington, DC: Resources for the Future, 2003.

**FIGURE CAPTIONS**

Figure 1. (a) The use of a resource, and the degree to which it approaches the available stock, for a seven-day period in which all parameters are well known; (b) As with (a), but for a century time period for which the stock and rate of use are imperfectly known.

Figure 2. The links among the needs for and limits of sustainability. Squares: W = water, E = energy, R = nonrenewable resources, L = land. Ovals: D = domestic needs, A = agriculture, I = industry, N = nature.

Figure 3. Examples of complex systems: (left) a classical multi-level natural system; (center), a technological system based on stocks of material in use; (right) a technological-environmental system based on flows of materials and energy.

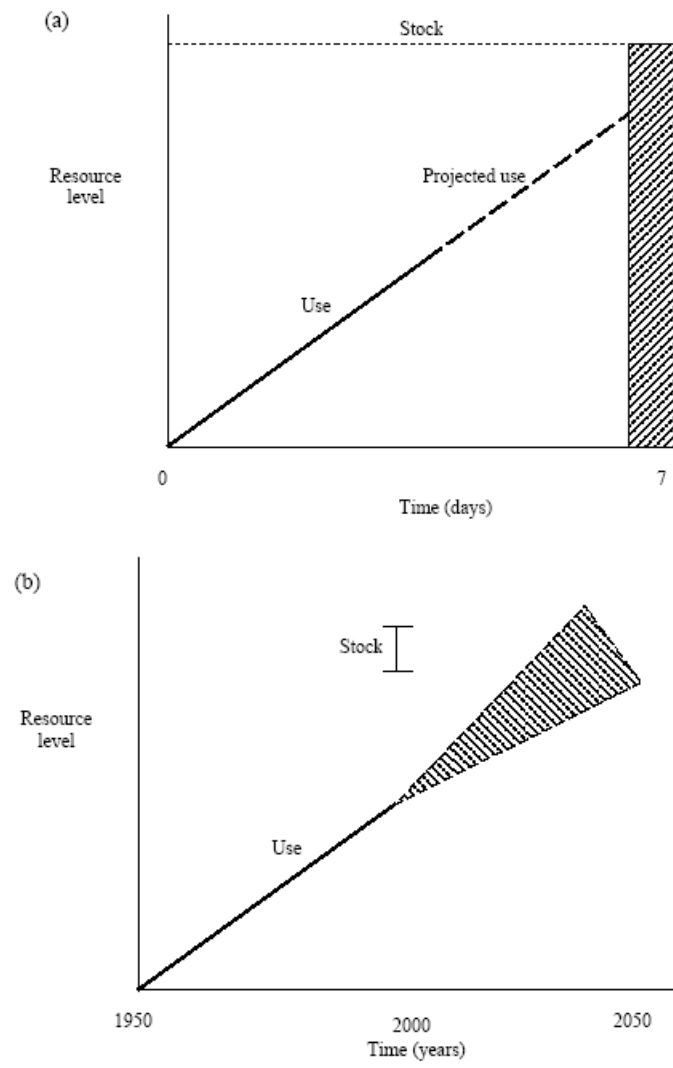

Figure 1

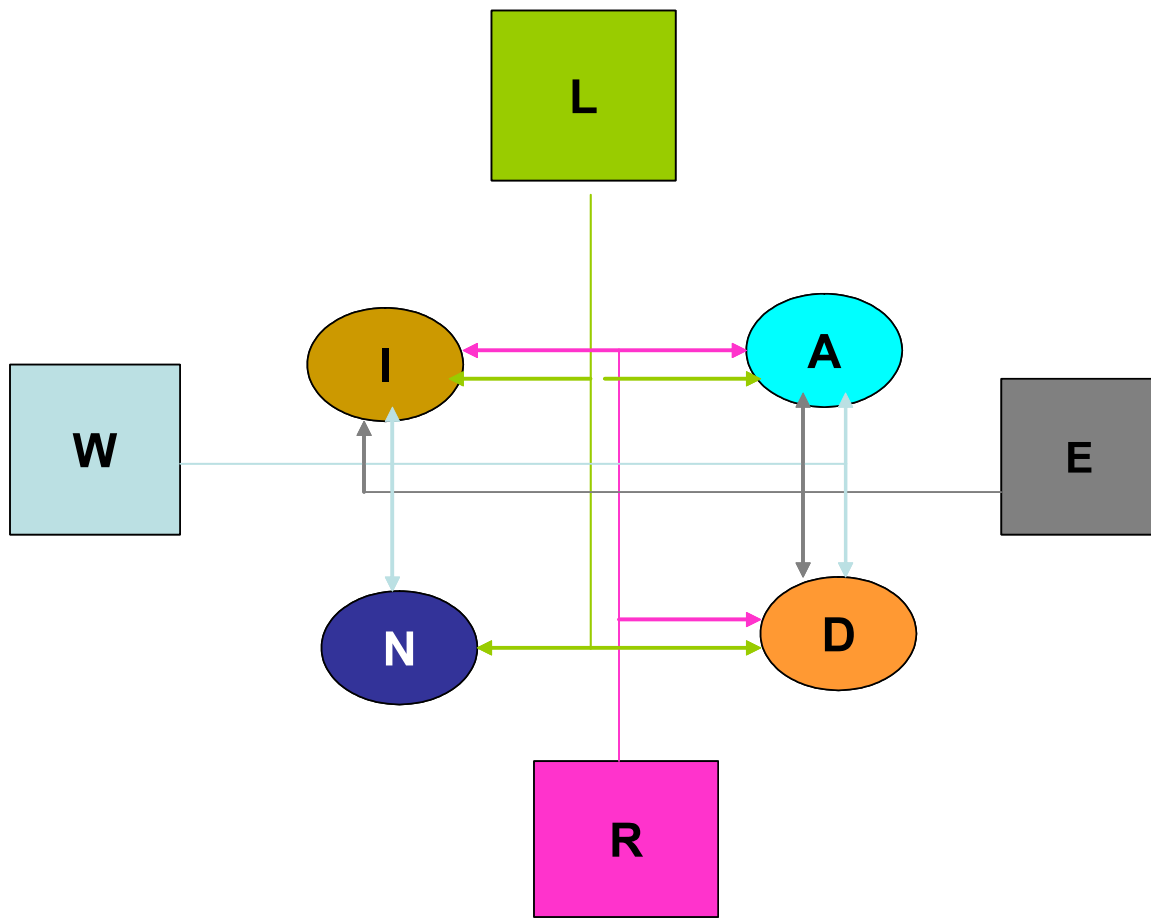

Figure 2

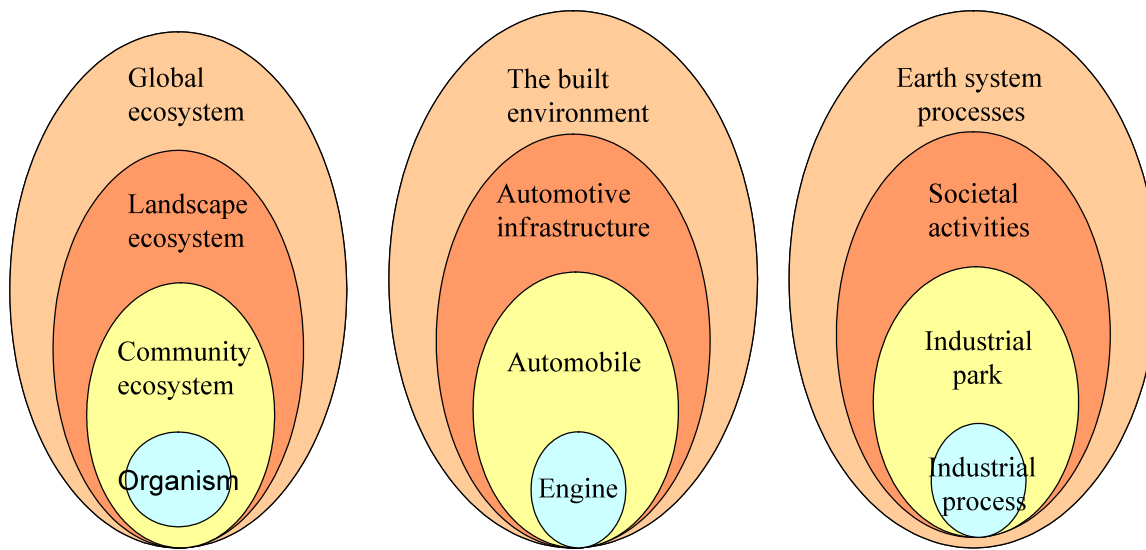

Figure 3



## Appendix D

### Summary of Themes and Research Questions Identified by the Working Groups

#### Working Group I: Human Well-Being and the Natural Environment

##### *A. How Can Analysis Contributing to Decision-Making about the Sustainable Development of Human-Environmental Systems Be Improved?*

1. How can sustainable development outcomes be compared/evaluated/ranked? What are the advantages and disadvantages of different measures of human well-being (e.g., psychological, economic, health and nutrition measures) and how can we aggregate measures of human well-being across different individuals and groups?
2. How can the measurement and valuation of ecosystem services be improved to better understand the link between environmental conditions and human well-being? What are the relationships between changes in social-ecological systems and changes in ecosystem services?
3. How can multiple tradeoffs among ecosystem services and other components of human well-being be quantified or characterized, and how can this best inform real-world decision-making?
4. How is decision-making informed and affected by the spatial or temporal scales of assessment and system dynamics?
5. How should assessments take account of intra-generational and inter-generational equity considerations in the comparisons/evaluations/rankings of sustainable development outcomes? In dealing with long-run consequences, are additional approaches besides discounting needed to aggregate across time?
6. How do different approaches (from expert-driven to deliberative democratic approaches) for treating values in the decision-making processes affect the comparisons/rankings of sustainable development outcomes? What factors determine the acceptability of different processes (and their associated outcomes) to participants and others?

##### *B. How Can Technological Innovation Be Induced and Harnessed to Support Sustainable Development?*

1. How can technological innovations be evaluated to determine their importance to sustainability? What aspects of innovations (e.g., energy minimization, resource utilization, etc.) might be most useful for sustainable development?

2. How best can innovation be encouraged to reduce environmental impacts from existing technology be promoted and how best can innovations leading to environmental degradation be discouraged?

3. How well will different policies and regulatory mechanisms induce sustainable technical or social innovation, either by dramatically reduced life-cycle use of energy and materials, or through the substitution of low-impact services for products? How well will different policies and regulatory mechanisms promote rapid adoption and use of these technologies?

4. What strategies, policies and institutions can best avoid economic or political lock-in when technologies and their associated institutions are anticipated to be useful in the short term but potentially detrimental to long-term sustainability?

5. How can integrated assessments (including technical, engineering, economic, market components) be improved to develop confidence that large-scale subsidies for deploying a technology will (or will not) quickly drive costs down to a level that makes it competitive in the market or make it socially desirable when environmental and social consequences are included?

6. How can technology forecasting be improved to yield a greater probability that the outcome of projected variables will lie within projected confidence intervals, and thus better support choices for sustainable development?

7. What are the likely unintended consequences – both social and environmental – of adoption and diffusion of new technologies and how well can these consequences be predicted before the wide-scale adoption and diffusion of new technology? What are promising approaches to policy design to reduce negative (increase positive) side-effects of new technology?

***C. What Are the Implications of Heterogeneous and Changing Consumption Patterns for Sustainable Development, and What Strategies Related to Consumption Could Enhance Sustainable Development?***

1. What is the relationship between resource consumption and human well-being and to what extent can the two be de-coupled?

2. What strategies can change high consumption patterns to reduce material/energy use while sustaining or improving human well-being?

3. What strategies can change low consumption patterns to better meet human needs while minimizing environmental impacts?

4. As wealth increases, what incentives and enabling conditions can lead to dematerialization of consumption (e.g., material use transition akin to the demographic

transition) consistent with sustainable development?

5. What motivates consumption, especially of material and energy that affect sustainable development, and upon what factors does it depend?

6. How will changing demographics and education alter consumption patterns and sustainable development?

7. How can the resource utilization embodied in global consumption be related to and constrained by limits to resource availability?

***D. What Are the Relationships between Collective Social Phenomena and Sustainable Development, and How Can We Explain these Relationships?***

1. How does the rapid migration to cities influence sustainable development? What changes in social and population structures will follow and how will these changes affect sustainable development?

2. Are there scaling rules for sustainable development similar to those that have been observed relating city size, energy consumption, and production of intellectual capital? What factors underlie such rules?

3. How can network models and other innovative approaches be applied to achieve a better understanding of social interactions and their influence on sustainable development?

4. What factors differentiate institutions and their development that encourage or discourage sustainable development? Under what circumstances do institutions resist change rather than adapt and evolve to be more consistent with sustainable development?

5. To what extent might social innovations (e.g., a move to product services that reduce the need for each household to buy equipment they seldom use) serve to supplement and enhance technological solutions that promote sustainable development?

6. How can long-term paleo and historical evidence better inform current sustainability themes, including how long- and short-term processes led to successes and failures in coupled systems in the past?

**Working Group II: Human-Environment Systems (HES) as Complex Adaptive Systems**

***A. Characterizing and Understanding Complex HESs.***

1. What kinds of models and model typologies are useful to a. represent, b. understand, c. predict HES emergent properties and macroscopic behavior?

2. Can we develop a typology of behavior and structure?
3. What characterizes transitions between states?
4. What is the role of innovation?

***B. Local Adaptive Responses and their Global Consequences.***

1. How do mechanisms that allow HES to adapt to short-term change affect their capacity to solve other types of problems?
2. Given that structures in HESs may evolve to link systems across scales, how do shocks, both desirable and undesirable, cascade through HES?
3. Are there general features of CAS that tend to suppress variation at particular frequencies/scales that, especially in the case of HES, lead to particular efficiency/robustness (performance) trade-offs?

***C. Characterizing Tradeoffs in HESs.***

1. Which tradeoffs (between development goals, different aspects of environmental quality, or between environment and development) are persistent or pervasive across different types (classifications) of adaptively complex human environment systems? Which change in predictable ways as systems develop or go through transitions?
2. Which tradeoffs are amenable to reduction or elimination through institutional, socioeconomic, or technological innovation?
3. What types of international institutions are required to navigate tradeoffs that currently fall outside of national or regional jurisdictions? How could these institutions facilitate international collective action or cooperation? How can such collective action fairly recognize different perspectives (aggregate different or competing preferences) to achieve more sustainable outcomes?
4. Under what circumstances does a complex adaptive systems perspective help us to better understand tradeoffs – how and where they arise, and how they differ and are resolved across scales of space, time, and social organization?

***Cross-Group Questions***

*Decision Making as Social Choice*

1. What are the institutional mechanisms (rules) that allow the content of scientific discoveries to play a role in the manifestation of decision choices?

2. What forms of analysis provide most effective insight into how the decision choices interact with the parameters of a human-environment system?
3. What forms of communication between scientists and decision makers are most effective at informing the decision choices?
4. What are the social and community norms that frame, and possibly inhibit, effective decision support?
5. How are decisions made when information about constituent choices is limited or non-existent, and/or the context is one of bureaucratic or judicial decision making rather than legislative decision making?

#### *Dynamic Decision Support*

1. How does voting (decision-making) behavior change when dynamic feedback is included?
2. By what mechanism, and on what time-scale, can the consequences of HES decisions be monitored?
3. What is the most effective form of analysis and communication of the consequences of previous decisions for informing the next decision?

### **Working Group III: Measuring and Monitoring Progress Toward Sustainability**

#### ***A. A New Generation of Models for the Study of Sustainable Development.***

1. Bridging domains such as food, water, energy, non-renewable resources, etc.
2. Co-evolution of models and monitoring.
3. Validation and relationships among models and data.
4. Assessing and communicating uncertainty.
5. Integrating models and scenarios.

#### ***B. What Should Be Measured and Monitored to Understand and Evaluate Our Progress towards Sustainability and Improved Human Well-Being?***

1. Tracking the stocks and flows involved with critical planetary life support systems – in terms of water, carbon, nitrogen, energy sources, minerals, etc. – that are fundamental to environmental sustainability and human well-being.

2. Tracking the security of food, freshwater, energy, health, biodiversity, etc. at scales of human impact, action and response.
3. What are the critical parameters for sustainability that need to be measured and monitored?
4. How can methods for data integration and synthesis be developed or enhanced?
5. Where are the critical places that data should be monitored for each parameter and at what scale?
6. What makes measuring and monitoring efforts effective?
7. What makes monitoring resilient and long-lasting?
8. What makes monitoring adaptable to changing needs?

***C. Creating, Maintaining and Using Long-Term, Place-Based Observations to Measure Progress toward or Movement away from Sustainability.***

1. How may the existing long-term, place-based monitoring systems be combined, expanded, and coordinated to meet critical information needs?
2. What makes some monitoring systems more effective than others?
3. Under what conditions will decision-makers invest in monitoring systems and make use of resulting data?

***D. Transitions: Towards and away from Sustainability.***

*1. Critical Transitions: Early Warnings of “Tipping Points” of Complex Systems Change.*

- a. Detailed studies of relatively realistic models are needed to determine when early warnings can be expected, when false positives or false negatives may occur, and to build understanding of mechanisms of early warnings.
- b. There is enormous need for field studies of early warnings (or lack thereof) in human-environment systems undergoing transitions. When do early warnings occur, when are they heeded and acted upon, and what actions are effective?
- c. Research is needed on the characteristics of policies or management systems that are capable of using early warnings to prevent unwanted transitions or trigger desirable transitions when opportunities arise.

*2. The WEHAB Plus Transitions of the Longue Duree: Powerful Drivers Towards and away from Sustainability.*

- a. How reliable are the posited transitions in demography, health, energy, non-renewable resources, food and urban dwelling, and how can newly appearing deviations be explained?
- b. Are there mechanisms by which societies can accelerate the favorable transitions and slow the ones that make sustainability more difficult?
- c. Is there an underlying common pattern to these transitions that transcends their subject matter and provides insight into what controls their dynamics?

*3. The Sustainability Transition: Alternative Science-Based Scenarios of the Moving Target of Sustainability.*

- a. Research should examine the existing sets of global scenarios in relation to observed global trajectories since 1990.
- b. Research is needed to explore processes for scenario construction for local and regional places that integrates local participation and vision with regional and global trends.
- c. A new generation of interdisciplinary scenarios for sustainability transitions should be developed, combining qualitative and quantitative approaches, and explicitly addressing interactions across scales from global, to national, to local.

## **Working Group IV: Managing Human-Environment Systems for Sustainability**

### ***A. Knowledge Systems for Sustainable Development.***

1. What are best practices for information/theory-to-practice linkages?
2. How and under what conditions does better information lead to better decisions?
3. How can networks be best designed or modified to mobilize critical knowledge and information and effectively address sustainable development goals?
4. What processes induce or constrain innovation in the development of new technologies or management approaches for sustainable development?
5. How can branch points (critical decision points) be determined and used to manage or shift sustainability trajectories and move onto a more sustainable course in rapidly changing systems (e.g., cities, rural areas, agriculture)?

6. How can deliberative learning be imbedded into management systems?
7. Do differences among complex systems (or classes of complex systems) influence the optimal decision or management approach and the kinds of decision support systems that are needed?

***B. Designing Management Systems for Sustainability under Uncertainty.***

1. How does the decision-making framework change over the course of unexpected events?
2. Develop designs that allow input over different time frames, recognizing importance of information about the definition of the baseline conditions, actions over time, time profile of costs, etc.
3. Develop methods for evaluating of tradeoffs associated with the options and their consequences (e.g., tradeoffs between vulnerable and politically powerful stakeholders and between present and future generations, costs of resilience, evaluation of the costs of the flooding to groups differing in income and ability to adjust).
4. Develop methods to identify attributes of systems that would allow us to identify those that admit the robust versus the monitored system; does the scale of the outcomes affect the judgment.
5. Develop understanding of the properties of instruments to implement management decisions and how are they are affected by what can be monitored.

***C. Adaptive Governance Systems for Sustainability.***

1. What is the relationship between characteristics of governance systems and the capacity of those systems to adapt to change?
2. What attributes enable governance systems to manage multiple interacting goals to achieve favorable outcomes?
3. How can various governance structures incentivize, facilitate, and enable behavior that fosters sustainability?
4. How do cross-scale interactions influence the integration of interacting elements?
5. How do historical legacies and current power structures influence opportunities and barriers to adaptive governance?